

SELCOM CAR DOOR *PORTE DI CABINA SELCOM*

Pegasus PLUS

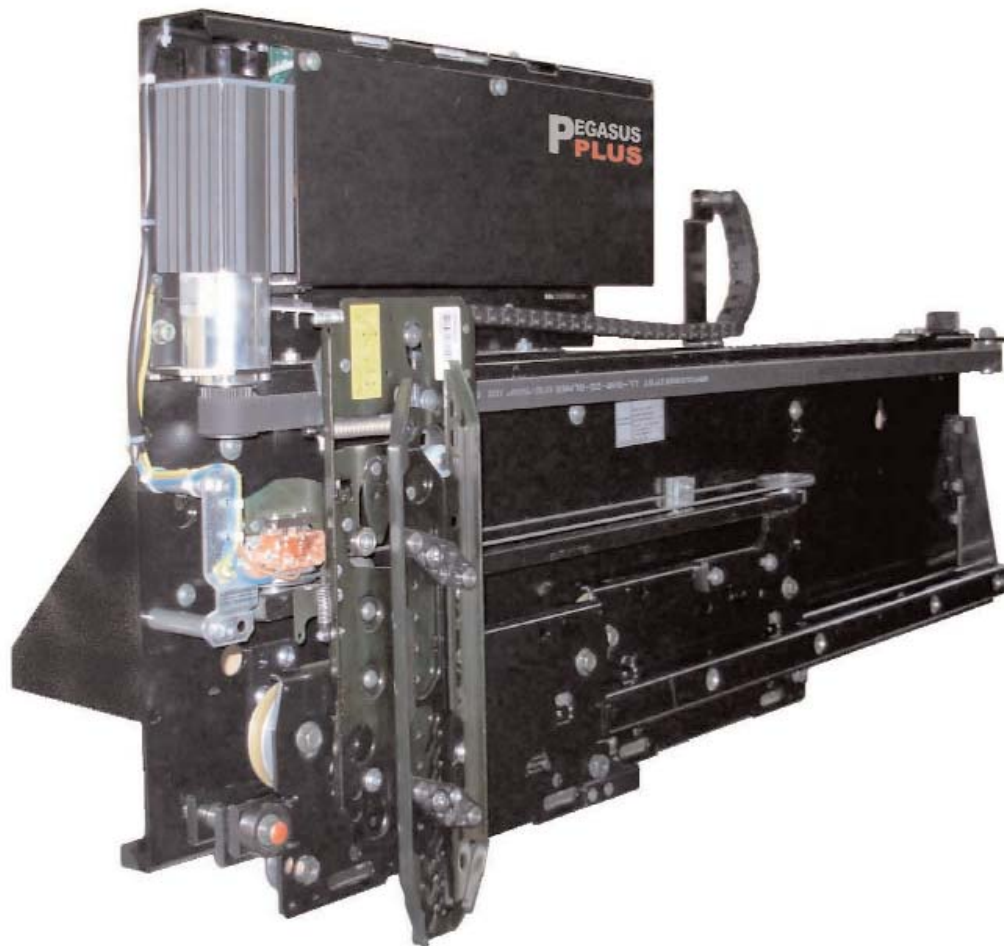

No part of this publication may be reproduced or translated, even in part, without prior written permission from WITTUR.

Questa pubblicazione non può essere riprodotta né tradotta, né interamente né in parte senza autorizzazione scritta della WITTUR.

© Copyright WITTUR 2010

URL: <http://www.wittur.com>
e-mail: info@wittur.com

© Copyright WITTUR 2010

Subject to change without notice!

Soggetto a modifica senza preavviso!



CAR DOOR PEGASUS PLUS
PORTE DI CABINA PEGASUS PLUS

Code/Codice TC.2.001999.EN
Version/Versione /

GENERAL INDEX
INDICE GENERALE

Code/Codice 3214.30.0600V01
Version/Versione B
Date/Data 12.10.2010
Page/Pagina 0.1

TECHNICAL DATA		DATI TECNICI
1.0	Technical Features	<i>Caratteristiche tecniche</i>
1.1	Production Range	<i>Gamma di produzione</i>
1.1.1	Application Range	<i>Campo di applicazione</i>
1.1.2	Technical Data	<i>Dati tecnici</i>
1.1.3	Technical Data	<i>Dati tecnici</i>
1.2	MIDI-SUPRA Drive Application Range - Standard and Fire Tested "E" and "EW" Class Panels	<i>Tabella applicazione motorizzazione MIDI-SUPRA - Ante standard e resistenti al fuoco classi "E" ed "EW"</i>
1.2.1	MIDI-SUPRA Drive Application Range - Standard and Fire Tested "E" and "EW" Class Panels	<i>Tabella applicazione motorizzazione MIDI-SUPRA - Ante standard e resistenti al fuoco classi "E" ed "EW"</i>
1.2.2	MIDI-SUPRA Drive Application Range - Standard and Fire Tested "E" and "EW" Class Panels	<i>Tabella applicazione motorizzazione MIDI-SUPRA - Ante standard e resistenti al fuoco classi "E" ed "EW"</i>
1.3	MIDI-SUPRA Drive Application Range - Fire Tested "EI" Class Panels	<i>Tabella applicazione motorizzazione MIDI-SUPRA - Ante resistenti al fuoco classe "EI"</i>
1.3.1	MIDI-SUPRA Drive Application Range - Fire Tested "EI" Class Panels	<i>Tabella applicazione motorizzazione MIDI-SUPRA - Ante resistenti al fuoco classe "EI"</i>
1.3.2	MIDI-SUPRA Drive Application Range - Fire Tested "EI" Class Panels	<i>Tabella applicazione motorizzazione MIDI-SUPRA - Ante resistenti al fuoco classe "EI"</i>
1.4	MIDI-SUPRA Drive Application Range - Glass and Glass-framed Panels	<i>Tabella applicazione motorizzazione MIDI-SUPRA - Ante in vetro e vetrate</i>
1.4.1	MIDI-SUPRA Drive Application Range - Glass and Glass-framed Panels	<i>Tabella applicazione motorizzazione MIDI-SUPRA - Ante in vetro e vetrate</i>
1.4.2	MIDI-SUPRA Drive Application Range - Glass and Glass-framed Panels	<i>Tabella applicazione motorizzazione MIDI-SUPRA - Ante in vetro e vetrate</i>
1.11	Car Door Overall Dimensions	<i>Dimensioni d'ingombro porta di cabina</i>
1.12	Opening and Closing Times (Standard, Double Skin and Fire Tested "E" and "EW" Class Panels)	<i>Tempi di apertura e chiusura (ante standard, tamburate e resistenti al fuoco classi "E" ed "EW")</i>
1.13	Opening and Closing Times (Standard, Double Skin and Fire Tested "E" and "EW" Class Panels)	<i>Tempi di apertura e chiusura (ante standard, tamburate e resistenti al fuoco classi "E" ed "EW")</i>
1.14	Opening and Closing Times (Fire Tested "EI" Class Panels)	<i>Tempi di apertura e chiusura (resistenti al fuoco classe "EI")</i>
1.15	Opening and Closing Times (Fire Tested "EI" Class Panels)	<i>Tempi di apertura e chiusura (resistenti al fuoco classe "EI")</i>
1.15.1	Opening and Closing Times (Glass, Glass-framed Panels)	<i>Tempi di apertura e chiusura (ante in vetro, e vetrate)</i>
1.15.2	Opening and Closing Times (Glass, Glass-framed Panels)	<i>Tempi di apertura e chiusura (ante in vetro, e vetrate)</i>
1.15.3	Bottom Fixings for Car Sills - Side Opening Car Doors	<i>Fissaggi inferiori soglie di cabina - Porte di cabina ad apertura laterale</i>
1.15.4	Bottom Fixings for Car Sills - Central Opening Car Doors	<i>Fissaggi inferiori soglie di cabina - Porte di cabina ad apertura centrale</i>
1.15.5	Car Door Infill Panel Schedule	<i>Tabelle dimensioni coprifessura superiori</i>
1.15.6	Car Door Infill Panel Schedule - Doors with Runby	<i>Tabelle dimensioni coprifessura superiori - porte con extracorsa</i>
1.16	Pegasus Plus Car Doors and Pegasus Landing Doors Arrangement	<i>Accoppiamento porte di cabina Pegasus Plus e porte di piano Pegasus</i>

Whilst every care has been taken in preparation of this catalogue, no liability can be accepted for any errors or omissions.

Sebbene la preparazione di questo catalogo sia stata realizzata con ogni cura, nessuna responsabilità potrà essere accettata per errori od omissioni.

Subject to change without notice!

Soggetto a modifica senza preavviso!





CAR DOOR PEGASUS PLUS
PORTE DI CABINA PEGASUS PLUS

Code/Codice TC.2.001999.EN
Version/Versione /

GENERAL INDEX
INDICE GENERALE

Code/Codice 3214.30.0600V01
Version/Versione A
Date/Data 12.10.2010
Page/Pagina 0.1.1

TECHNICAL DATA	DATI TECNICI
1.17 Car Door and Landing Door Arrangement with Standard Coupler	<i>Accoppiamento porta di cabina e porta di piano con abbinamento standard</i>
1.18 Car Door and Landing Door Arrangement with Coupler with Car Door Lock	<i>Accoppiamento porta di cabina e porta di piano con abbinamento con bloccaggio fuori piano</i>
1.19 Emergency Opening Device for Coupler with Car Door Lock	<i>Dispositivo di apertura d'emergenza con abbinamento con bloccaggio fuori piano</i>

Whilst every care has been taken in preparation of this catalogue, no liability can be accepted for any errors or omissions.

Sebbene la preparazione di questo catalogo sia stata realizzata con ogni cura, nessuna responsabilità potrà essere accettata per errori od omissioni.

Subject to change without notice!

Soggetto a modifica senza preavviso!



CAR DOOR PEGASUS PLUS PORTE DI CABINA PEGASUS PLUS

Code/Codice TC.2.001999.EN
Version/Versione /

GENERAL INDEX INDICE GENERALE

Code/Codice 3214.30.0600V01
Version/Versione A
Date/Data 12.10.2010
Page/Pagina 0.2

TWO PANELS TELESCOPIC DOORS		PORTE TELESCOPICHE DUE ANTE
2.1	Two Panels Telescopic Car Door Type 12/R-L C.O.=800÷1800	<i>Porta di cabina telescopica due ante, tipo 12/R-L PL=800÷1800</i>
2.1.t	Two Panels Telescopic Car Door Type 12/R-L C.O.=800÷1800 (Schedule)	<i>Porta di cabina telescopica due ante, tipo 12/R-L PL=800÷1800 (Tabella)</i>
TWO PANELS CENTRAL OPENING DOORS		PORTE CENTRALI DUE ANTE
3.1	Two Panels Central Opening Car Door Type 02/C C.O.=750÷1800	<i>Porta di cabina due ante opposte, tipo 02/C PL=750÷1800</i>
3.1.t	Two Panels Central Opening Car Door Type 02/C C.O.=750÷1800 (Schedule)	<i>Porta di cabina due ante opposte, tipo 02/C PL=750÷1800 (Tabella)</i>
THREE PANELS TELESCOPIC DOORS		PORTE TELESCOPICHE TRE ANTE
4.1	Three Panels Telescopic Car Door Type 32/R-L C.O.=900÷2100	<i>Porta di cabina telescopica tre ante, tipo 32/R-L PL=900÷2100</i>
4.1.t	Three Panels Telescopic Car Door Type 32/R-L C.O.=900÷2100 (Schedule)	<i>Porta di cabina telescopica tre ante, tipo 32/R-L PL=900÷2100 (Tabella)</i>
FOUR PANELS CENTRAL OPENING DOORS		PORTE TELESCOPICHE-CENTRALI QUATTRO ANTE
5.1	Four Panels Central Opening Car Door Type 42/C C.O.=1300÷3200	<i>Porta di cabina quattro ante opposte, tipo 42/C PL=1300÷3200</i>
5.1.t	Four Panels Central Opening Car Door Type 42/C C.O.=1300÷3200 (Schedule)	<i>Porta di cabina quattro ante opposte, tipo 42/C PL=1300÷3200 (Tabella)</i>
SIX PANELS CENTRAL OPENING DOORS		PORTE TELESCOPICHE-CENTRALI SEI ANTE
6.1	Six Panels Central Opening Car Door Type 62/C C.O.=1800÷3200	<i>Porta di cabina sei ante opposte, tipo 62/C PL=1800÷3200</i>
6.1.t	Six Panels Central Opening Car Door Type 62/C C.O.=1800÷3200 (Schedule)	<i>Porta di cabina sei ante opposte, tipo 62/C PL=1800÷3200 (Tabella)</i>
ONE PANEL CAR DOORS		PORTE AD UN ANTA SCORREVOLE
7.1	One Panel Car Door Type 72/R-L C.O.=600÷1400	<i>Porta di cabina un'anta, tipo 72/R-L PL=600÷1400</i>
7.1.t	One Panel Car Door (Schedule) Type 72/R-L C.O.=600÷1400	<i>Porta di cabina un'anta, tipo 72/R-L PL=600÷1400 (Tabella)</i>

Whilst every care has been taken in preparation of this catalogue,
no liability can be accepted for any errors or omissions.

Sebbene la preparazione di questo catalogo sia stata realizzata
con ogni cura, nessuna responsabilità potrà essere accettata per
errori od omissioni.

Subject to change without notice!

Soggetto a modifica senza preavviso!





WITTUR

CAR DOOR PEGASUS PLUS PORTE DI CABINA PEGASUS PLUS

Code/Codice TC.2.001999.EN
Version/Versione /

TECHNICAL FEATURES

CARATTERISTICHE TECNICHE

Code/Codice 3214.30.0600V01
Version/Versione A

Date/Data 12.10.2010
Page/Pagina 1.0

Features:

Pegasus Plus is a door system which can be used with any kind of application, from residential buildings up to highly frequented office buildings and hotels. The compact construction ensures high flexibility especially for elevator modernization purposes. Well thought out design and the use of selected materials mean additional advantages like:

- Modularity:
 - various combinations between Drives and Models (Pegasus - Hydra - Augusta);
 - combinations between Pegasus, Hydra and Augusta are possible in one elevator (i.e. Pegasus=high traffic
Hydra=medium traffic
Augusta=low traffic).

	Car Door	Landing Door
Possible Combinations:	Pegasus Plus	Pegasus Hydra Augusta
	Hydra Plus	Hydra Augusta
	Eco Augusta	Augusta

- Standard fixing on cabin roof like previous models Pegasus Arm or Pegasus Belt.
- Wide range with 9 door types.
- Smooth operation even at high door speeds.
- Integrated car door lock in coupler (optional).
- Clear opening self learning.
- Low energy consumption.
- Global product: **Pegasus Plus** complies with the standards: EN81, Pubel, Lift Directive 95/16/EC.
- Closing times according to disable people rules.
- Small numbers of parts result in reduced number of spares and highly increased lifetime.
- If needed adaptations at existing components and special designed parts are possible.

Content of Supply of operator:

- Door operator consisting of: Drive (Motor, Electronic board, Transformer), Mechanism, Coupler, Panels, Sill, Toeguard.
- Semiautomatic system (option).
- Front fixing (option).
- Car door lock (option).
- Cable chain set (option).
- Application of extra safety devices: photocell and electronic detector (option).
- Protection class IP54 (option).
- Operating instructions.

Caratteristiche:

Pegasus Plus è un operatore che può essere utilizzato per qualsiasi tipo di applicazione, dagli edifici residenziali fino agli uffici e agli alberghi molto frequentati. La costruzione compatta nelle dimensioni garantisce alta flessibilità specialmente per la modernizzazione degli impianti. Un'avanzata progettazione e l'uso di materiali scelti portano ulteriori vantaggi, quali:

- Modularità:
 - varie combinazioni tra motorizzazioni e modelli (Pegasus - Hydra - Augusta);
 - sono possibili combinazioni tra Pegasus, Hydra e Augusta nello stesso impianto (cioè: Pegasus per piani molto frequentati, Hydra per piani mediamente frequentati, Augusta per piani poco frequentati).

	Porta di cabina	Porta di piano
Possibili combinazioni:	Pegasus Plus	Pegasus Hydra Augusta
	Hydra Plus	Hydra Augusta
	Eco Augusta	Augusta

- Fissaggi standard su tetto cabina uguali ai precedenti modelli Pegasus Arm o Pegasus Belt.
- Ampia gamma con 9 tipi di porta.
- Ottima scorrevolezza anche ad alte velocità.
- Bloccaggio fuori piano integrato nell'abbinamento (a richiesta).
- Autoapprendimento del passaggio libero.
- Basso consumo energetico.
- Prodotto universale: **Pegasus Plus** rispetta le normative EN81, Pubel, Lift Directive 95/16/EC.
- Tempi di chiusura secondo norme per disabili.
- Un basso numero di componenti comporta un ridotto numero di ricambi e una durata molto elevata.
- Se necessari, sono possibili adattamenti a componenti esistenti e pezzi speciali a disegno.

Materiale di fornitura dell'operatore:

- L'operatore è composto da: motorizzazione (motore, scheda elettronica, trasformatore), meccanismo, abbinamento, ante, soglia, paramento.
- Sistema semiautomatico (a richiesta).
- Fissaggio frontale (a richiesta).
- Bloccaggio fuori piano (a richiesta).
- Gruppo guidacavi (a richiesta).
- Applicazione di dispositivi di sicurezza supplementari: fotocellula e costole elettroniche (a richiesta).
- Classe di protezione IP54 (a richiesta).
- Istruzioni d'uso.



CAR DOOR PEGASUS PLUS

PORTE DI CABINA PEGASUS PLUS

Code/Codice TC.2.001999.EN
Version/Versione /

PRODUCTION RANGE
GAMMA DI PRODUZIONE

Code/Codice 3214.30.0600V01
Version/Versione A
Date/Data 12.10.2010
Page/Pagina 1.1

POS.	SERIE	LANDING DOORS PORTE DI PIANO		CAR DOORS PORTE DI CABINA		C.O. PL mm.		LH mm.	
		TYPE TIPO	ILLUSTRATION RAPPRESENTAZIONE	TYPE TIPO	ILLUSTRATION RAPPRESENTAZIONE	Min.	Max.	Min.	Max.
DOOR WITH OPERATOR ABOVE PORTA CON MECCANISMO SOPRA LA CABINA	3201	01/C		02/C		750	1800	2000	NOTE: MAXIMUM CLEAR OPENING HEIGHT 3500 mm. - SUBJECT TO CLEAR OPENING WIDTH N.B.: LA MASSIMA APERTURA IN ALTEZZA È 3800 mm. DEVE ESSERE DEFINITA OGNI VOLTA IN RELAZIONE AL PASSAGGIO LIBERO DELLA PORTA
		11/R		12/R		800	1800		
		11/L		12/L		900	2100		
		31/R		32/R		1300	3200		
		31/L		32/L		1800	3200		
		41/C		42/C		600	1400		
		61/C		62/C					
		71/R		72/R					
		71/L		72/L					



CAR DOOR PEGASUS PLUS
PORTE DI CABINA PEGASUS PLUS

Code/Codice TC.2.001999.EN
Version/Versione /

APPLICATION RANGE
CAMPO DI APPLICAZIONE

Code/Codice 3214.30.0600V01
Version/Versione A
Date/Data 12.10.2010
Page/Pagina 1.1.1

Drive Motore	Usage Area Area di utilizzo	
MIDI	Medium-high traffic installation <i>Impianti con medio-alto traffico</i>	Public buildings, offices, medium-high traffic residential buildings and prestigious buildings <i>Edifici pubblici, uffici, edifici residenziali a medio-alto traffico e di prestigio</i>
SUPRA	High traffic installation <i>Impianti con alto traffico</i>	Hotels, hospitals, ships, public buildings, offices, high traffic residential buildings and prestigious buildings <i>Hotels, ospedali, navi, edifici pubblici, uffici, edifici residenziali ad alto traffico e di prestigio</i>



CAR DOOR PEGASUS PLUS
PORTE DI CABINA PEGASUS PLUS

Code/Codice TC.2.001999.EN
Version/Versione /

TECHNICAL DATA
DATI TECNICI

Code/Codice 3214.30.0600V01
Version/Versione B
Date/Data 12.10.2010
Page/Pagina 1.1.2

	MIDI	SUPRA
Motor Characteristics <i>Caratteristiche del motore</i>	DC Motor	AC 3 Phase Motor
Drive <i>Motorizzazione</i>	PWM (Pulse Width Modulation)	V3F - Converter
Average Power Consumption <i>Consumo medio</i>	120W	170W
Max Momentary Power Consumption <i>Massimo consumo istantaneo</i>	550W	900W
Power Supply <i>Alimentazione</i>	Univ. (127V; 6A)±20% (230V; 4A)±20% 50/60Hz	Univ. (127V; 6A)±20% (230V; 4A)±20% 50/60Hz
Noise Level (Door Operator) <i>Livello di rumore (Operatore)</i>	average 55 dB, max 60 dB	average 50 dB, max 55 dB
Protection Class <i>Classe di protezione</i>	IP20, option IP54	IP20, option IP54
Regulations and Standards <i>Regolamenti e Norme</i>	EN81, PUBEL, Lift directive 95/16/EC	EN81, PUBEL, Lift directive 95/16/EC
Electromagnetic Compatibility <i>Compatibilità Elettromagnetica</i>	Immunity and Emission Protection acc. EN12015/16 <i>Protezione immunità ed emissioni come da EN12015/16</i>	
Maximum Movable Masses (Car and Landing Door Panels) <i>Peso massimo in movimento (Ante porta di cabina e di piano)</i>	300kg	700kg
Passenger Protective Device <i>Dispositivi di protezione dei passeggeri</i>	Photocell and Light Curtain (LSE-79) <i>Fotocellula e Cortina di luce (LSE-79)</i>	
Car Door Lock (Optional) <i>Bloccaggio fuori piano (Opzione)</i>	•	

- AVAILABLE
DISPONIBILE
- NOT AVAILABLE
NON DISPONIBILE



CAR DOOR PEGASUS PLUS
PORTE DI CABINA PEGASUS PLUS

Code/Codice TC.2.001999.EN
Version/Versione /

TECHNICAL DATA
DATI TECNICI

Code/Codice 3214.30.0600V01
Version/Versione A
Date/Data 12.10.2010
Page/Pagina 1.1.3

	MIDI	SUPRA
Shaft Room Temperature <i>Temperatura ambiente nel vano</i>	-20...+50°C	-20...+50°C
Storage Temperature <i>Temperatura di stoccaggio</i>	-45...+70°C	-45...+70°C
Humidity Range <i>Campo umidità</i>	<97%...<25°C <93%...40°C	97% max 40°C
Vibration (Test Value) <i>Resistenza alle vibrazioni (Valore di test)</i>	-	-
Bump (Test Value) <i>Resistenza alle scosse (Valore di test)</i>	-	-
Advanced opening <i>Preapertura</i>	•	•
Self Learning <i>Autoapprendimento</i>	•	•
Adjustment by PC <i>Settaggio mediante PC</i>	•	•
Supervision Function <i>Funzione di supervisione</i>	•	•
Data Stored Permanently <i>Dati memorizzati permanentemente</i>	•	•
Nudging (NUD) <i>Nudging (NUD)</i>	•	•
Opening Push Button in the Car (Optional) <i>Pulsante di apertura in cabina (a richiesta)</i> (DOB)	•	•
Protective Device - Power Supply <i>Dispositivo di sicurezza - Alimentazione</i>	24V DC + 10% 150 mA	24V DC + 10% 150 mA
Emergency Battery Drive <i>Batteria di emergenza</i>	18 - 26 VDC max 15A	18 - 26 VDC max 20A

• AVAILABLE
DISPONIBILE

- NOT AVAILABLE
NON DISPONIBILE

CAR DOOR PEGASUS PLUS PORTE DI CABINA PEGASUS PLUS

MIDI-SUPRA DRIVE APPLICATION RANGE

TABELLA APPLICAZIONE MOTORIZZAZIONE MIDI-SUPRA

STANDARD AND FIRE TESTED "E" AND "EW" CLASS PANELS

ANTE STANDARD E RESISTENTI AL FUOCO CLASSI "E" ED "EW"

Code/Codice TC.2.001999.EN
Version/Versione /

Code/Codice 3214.30.0600V01
Version/Versione B

Date/Data 12.10.2010
Page/Pagina 1.2.2

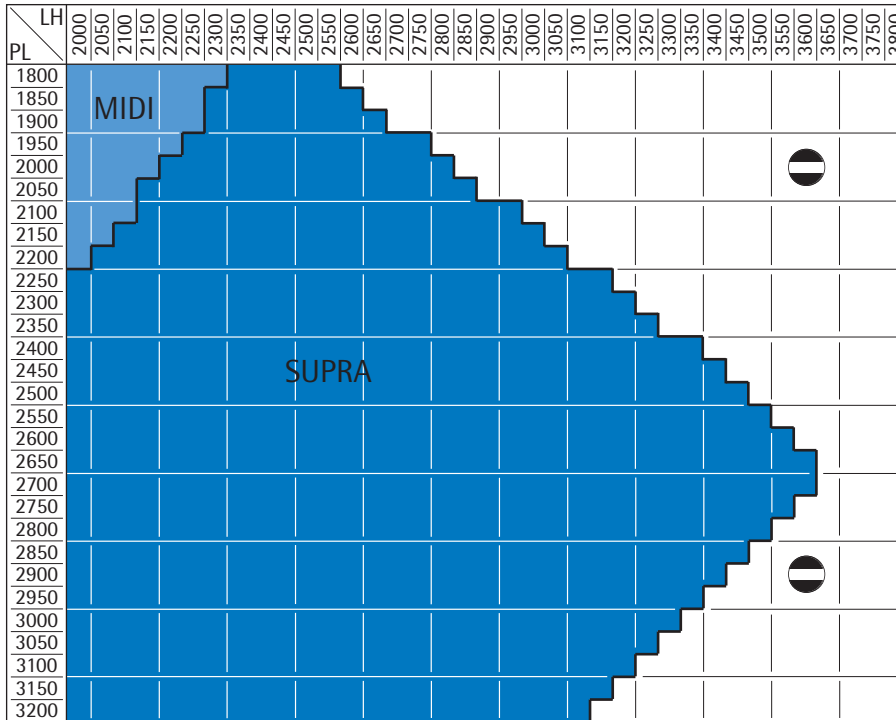

TY 62/C



FOR TYPE 61/C LANDING DOORS WITH
STANDARD, DOUBLE SKIN AND FIRE TESTED
"E" AND "EW" CLASS PANELS

PER PORTE DI PIANO TIPO 61/C CON
ANTE STANDARD, TAMBURATE E RESISTENTI
AL FUOCO CLASSI "E" ED "EW"

MAX. ALLOWABLE WEIGHT
PESO MASSIMO AMMISSIBILE
Landing and Car Door Panels
Ante di cabina e ante di piano

DRIVE MOTORIZZAZIONE	kg
-------------------------	----

MIDI	300
------	-----

SUPRA	700
-------	-----



NOT FEASIBLE DOORS
PORTE NON FATTIBILI

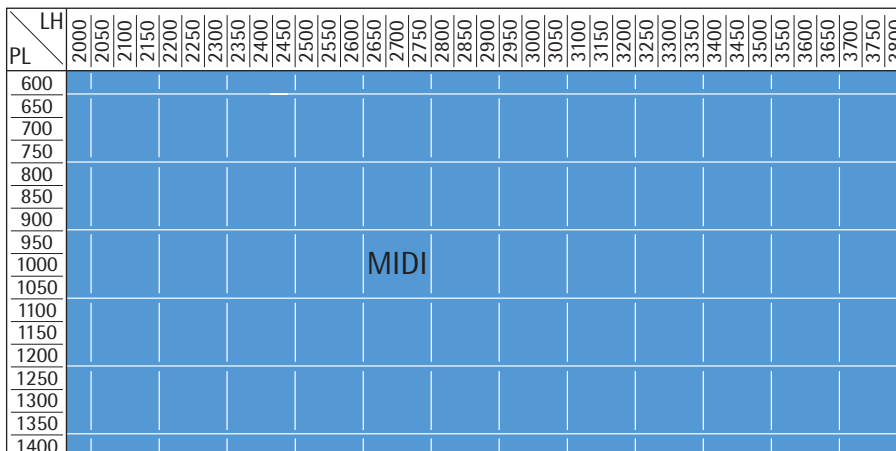

TY 72/R-L



FOR TYPE 71/R-L LANDING DOORS WITH
STANDARD, DOUBLE SKIN AND FIRE TESTED
"E" AND "EW" CLASS PANELS

PER PORTE DI PIANO TIPO 71/R-L CON
ANTE STANDARD, TAMBURATE E RESISTENTI
AL FUOCO CLASSI "E" ED "EW"

MAX. ALLOWABLE WEIGHT
PESO MASSIMO AMMISSIBILE
Landing and Car Door Panels
Ante di cabina e ante di piano

DRIVE MOTORIZZAZIONE	kg
-------------------------	----

MIDI	300
------	-----

CAR DOOR PEGASUS PLUS PORTE DI CABINA PEGASUS PLUS

MIDI-SUPRA DRIVE APPLICATION RANGE

TABELLA APPLICAZIONE MOTORIZZAZIONE MIDI-SUPRA

FIRE TESTED "EI" CLASS PANELS

ANTE RESISTENTI AL FUOCO CLASSE "EI"

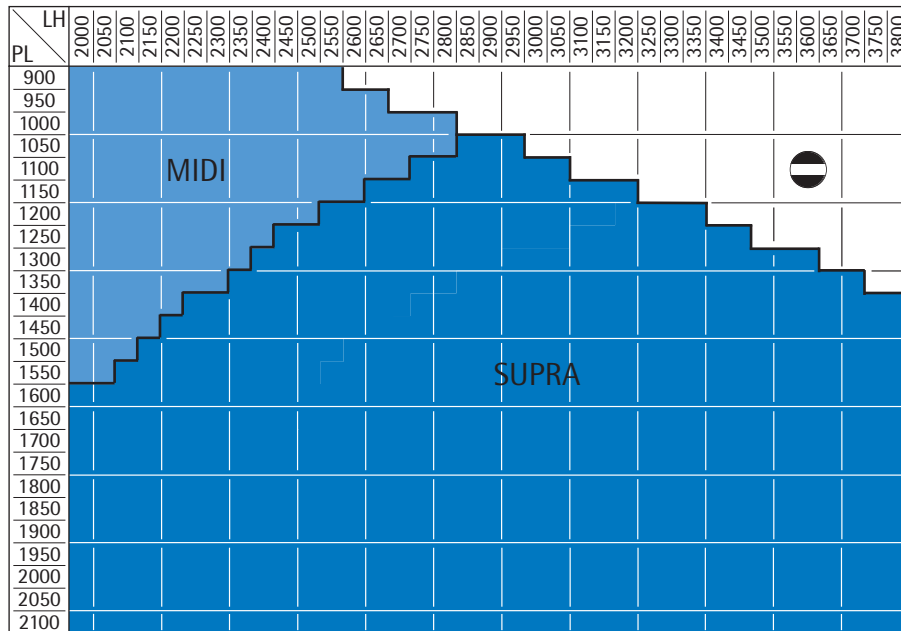

TY 32/R-L

FOR TYPE 31/R-L LANDING DOORS WITH
FIRE TESTED "EI" CLASS PANELS

PER PORTE DI PIANO TIPO 31/R-L CON ANTE
RESISTENTI AL FUOCO CLASSE "EI"

MAX. ALLOWABLE WEIGHT PESO MASSIMO AMMISSIBILE Landing and Car Door Panels Ante di cabina e ante di piano	
DRIVE MOTORIZZAZIONE	kg
MIDI	300
SUPRA	700

 NOT FEASIBLE DOORS
PORTE NON FATTIBILI

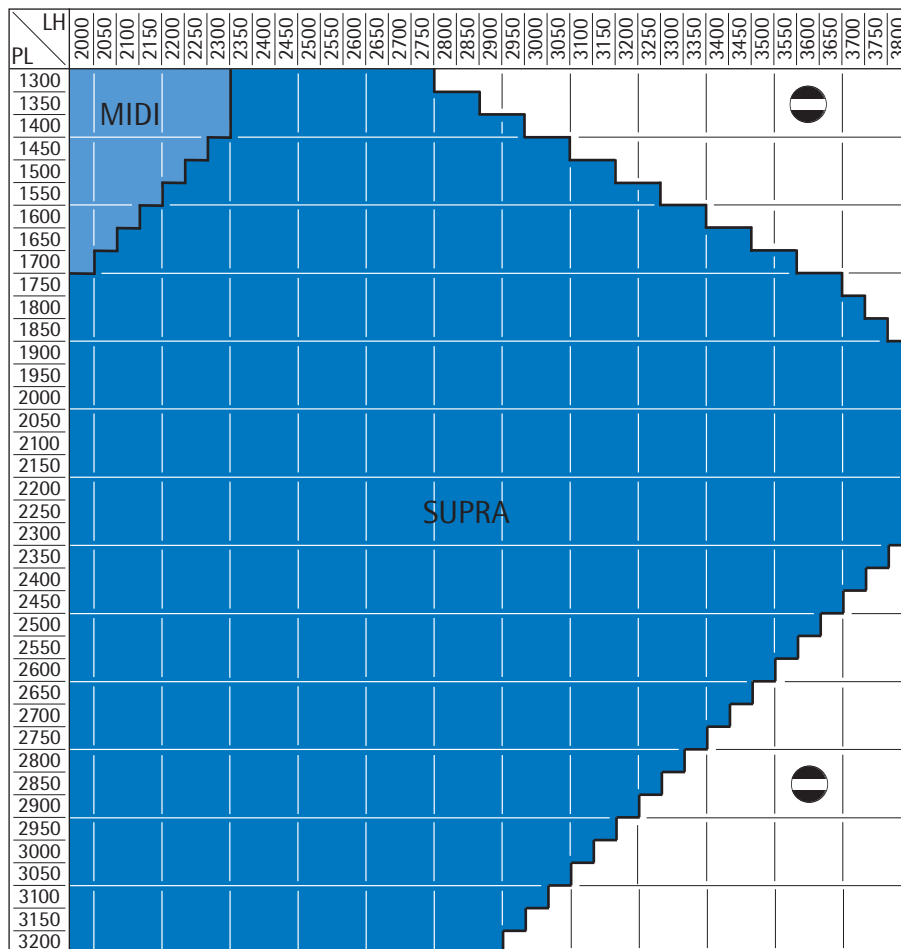

TY 42/C

FOR TYPE 41/C LANDING DOORS WITH
FIRE TESTED "EI" CLASS PANELS

PER PORTE DI PIANO TIPO 41/C CON ANTE
RESISTENTI AL FUOCO CLASSE "EI"

MAX. ALLOWABLE WEIGHT PESO MASSIMO AMMISSIBILE Landing and Car Door Panels Ante di cabina e ante di piano	
DRIVE MOTORIZZAZIONE	kg
MIDI	300
SUPRA	700

 NOT FEASIBLE DOORS
PORTE NON FATTIBILI

CAR DOOR PEGASUS PLUS PORTE DI CABINA PEGASUS PLUS

MIDI-SUPRA DRIVE APPLICATION RANGE

TABELLA APPLICAZIONE MOTORIZZAZIONE MIDI-SUPRA

FIRE TESTED "EI" CLASS PANELS
ANTE RESISTENTI AL FUOCO CLASSE "EI"

Code/Codice TC.2.001999.EN
Version/Versione /

Code/Codice 3214.30.0600V01
Version/Versione B

Date/Data 12.10.2010
Page/Pagina 1.3.2

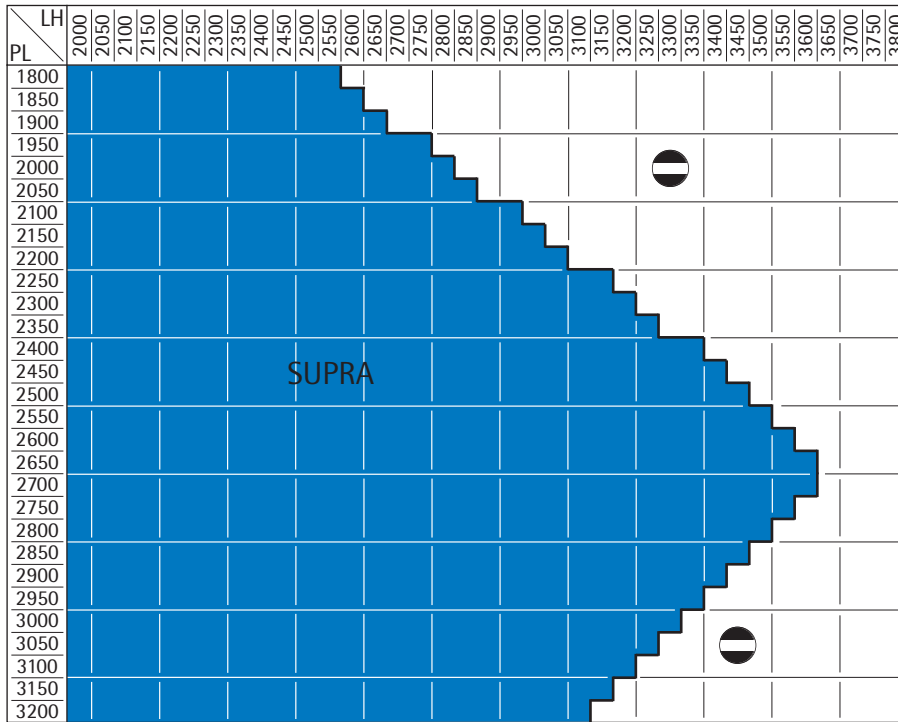

TY 62/C

FOR TYPE 61/C LANDING DOORS WITH
FIRE TESTED "EI" CLASS PANELS
PER PORTE DI PIANO TIPO 61/C CON ANTE
RESISTENTI AL FUOCO CLASSE "EI"

MAX. ALLOWABLE WEIGHT PESO MASSIMO AMMISSIBILE Landing and Car Door Panels Ante di cabina e ante di piano	
DRIVE MOTORIZZAZIONE	kg
SUPRA	700

 NOT FEASIBLE DOORS
PORTE NON FATTIBILI

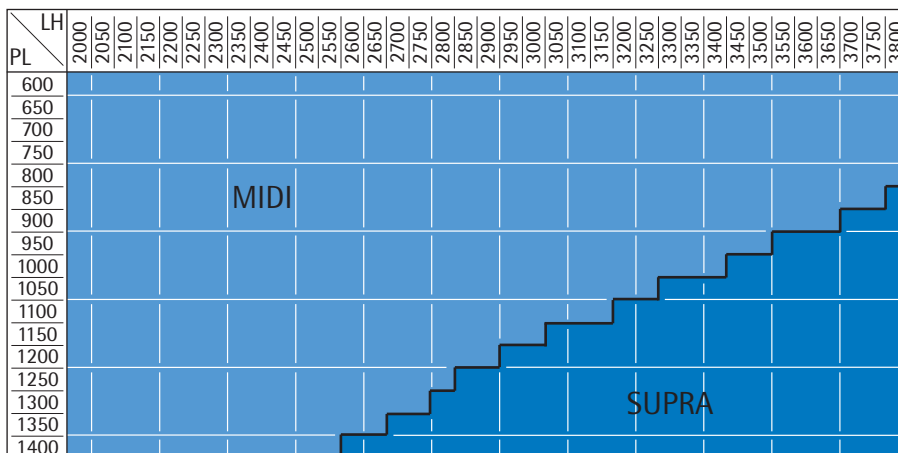

TY 72/R-L

FOR TYPE 71/R-L LANDING DOORS WITH
FIRE TESTED "EI" CLASS PANELS
PER PORTE DI PIANO TIPO 71/R-L CON ANTE
RESISTENTI AL FUOCO CLASSE "EI"

MAX. ALLOWABLE WEIGHT PESO MASSIMO AMMISSIBILE Landing and Car Door Panels Ante di cabina e ante di piano	
DRIVE MOTORIZZAZIONE	kg
MIDI	300
SUPRA	700

CAR DOOR PEGASUS PLUS PORTE DI CABINA PEGASUS PLUS

MIDI-SUPRA DRIVE APPLICATION RANGE

TABELLA APPLICAZIONE MOTORIZZAZIONE MIDI-SUPRA

GLASS AND GLASS-FRAMED PANELS

ANTE IN VETRO E VETRATE

Code/Codice TC.2.001999.EN
Version/Versione /

Code/Codice 3214.30.0600V01
Version/Versione C

Date/Data 12.10.2010
Page/Pagina 1.4

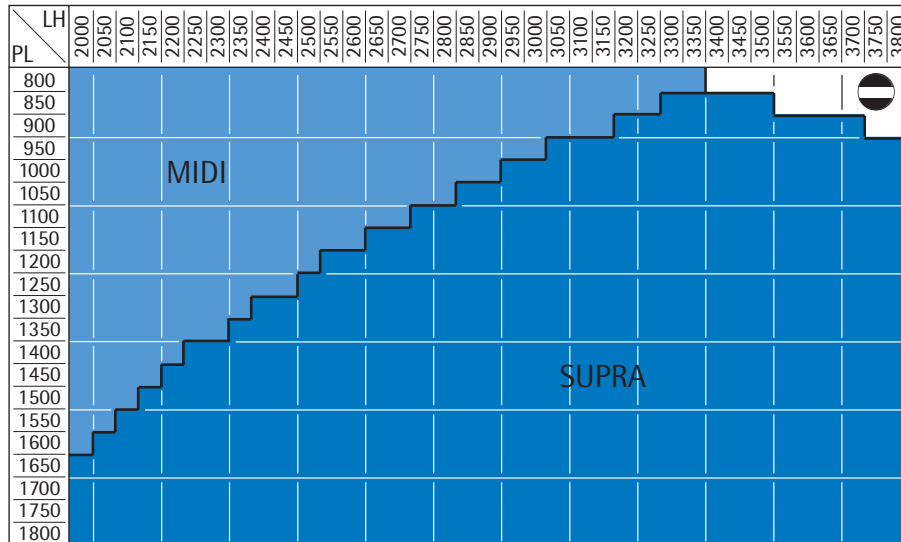

TY 12/R-L

FOR TYPE 11/R-L LANDING DOORS WITH
GLASS AND GLASS-FRAMED PANELS

PER PORTE DI PIANO TIPO 11/R-L CON ANTE
IN VETRO E VETRATE

MAX. ALLOWABLE WEIGHT PESO MASSIMO AMMISSIBILE Landing and Car Door Panels Ante di cabina e ante di piano	
DRIVE MOTORIZZAZIONE	kg
MIDI	300
SUPRA	700



NOT FEASIBLE DOORS
PORTE NON FATTIBILI

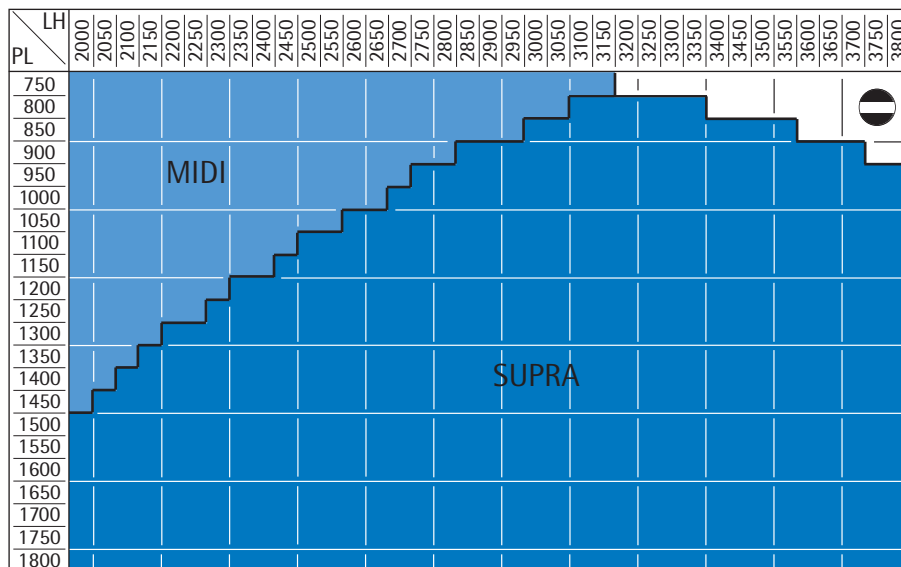

TY 02/C

FOR TYPE 01/C LANDING DOORS WITH
GLASS AND GLASS-FRAMED PANELS

PER PORTE DI PIANO TIPO 01/C CON ANTE
IN VETRO E VETRATE

MAX. ALLOWABLE WEIGHT PESO MASSIMO AMMISSIBILE Landing and Car Door Panels Ante di cabina e ante di piano	
DRIVE MOTORIZZAZIONE	kg
MIDI	300
SUPRA	700



NOT FEASIBLE DOORS
PORTE NON FATTIBILI

CAR DOOR PEGASUS PLUS PORTE DI CABINA PEGASUS PLUS

Code/Codice TC.2.001999.EN
Version/Versione /

MIDI-SUPRA DRIVE APPLICATION RANGE

Code/Codice 3214.30.0600V01
Version/Versione B

TABELLA APPLICAZIONE MOTORIZZAZIONE MIDI-SUPRA

Date/Data 12.10.2010
Page/Pagina 1.4.1

GLASS AND GLASS-FRAMED PANELS

ANTE IN VETRO E VETRATE

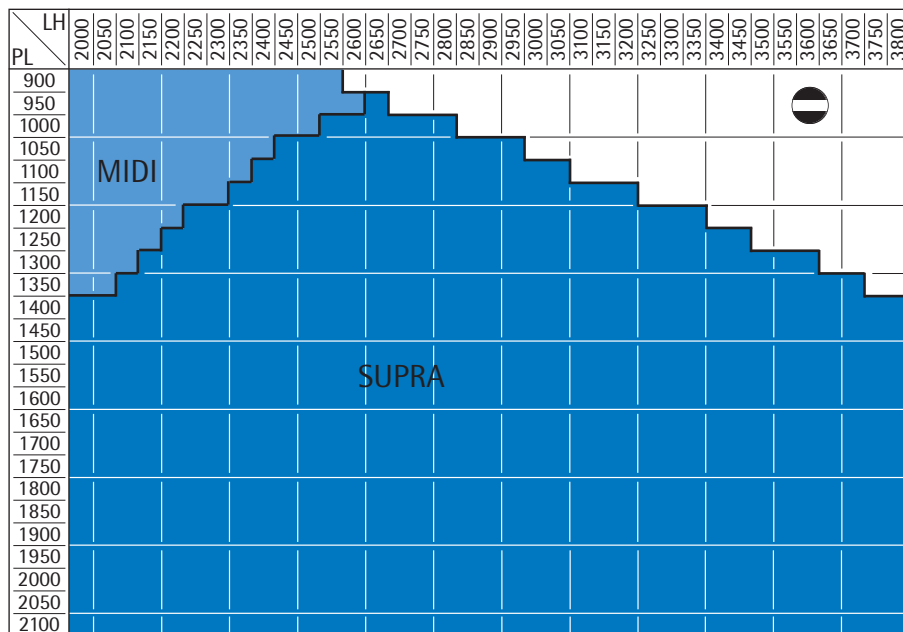

TY 32/R-L

FOR TYPE 31/R-L LANDING DOORS WITH
GLASS AND GLASS-FRAMED PANELS
PER PORTE DI PIANO TIPO 31/R-L CON ANTE
IN VETRO E VETRATE

MAX. ALLOWABLE WEIGHT PESO MASSIMO AMMISSIBILE Landing and Car Door Panels Ante di cabina e ante di piano	
DRIVE MOTORIZZAZIONE	kg
MIDI	300
SUPRA	700

 NOT FEASIBLE DOORS
PORTE NON FATTIBILI

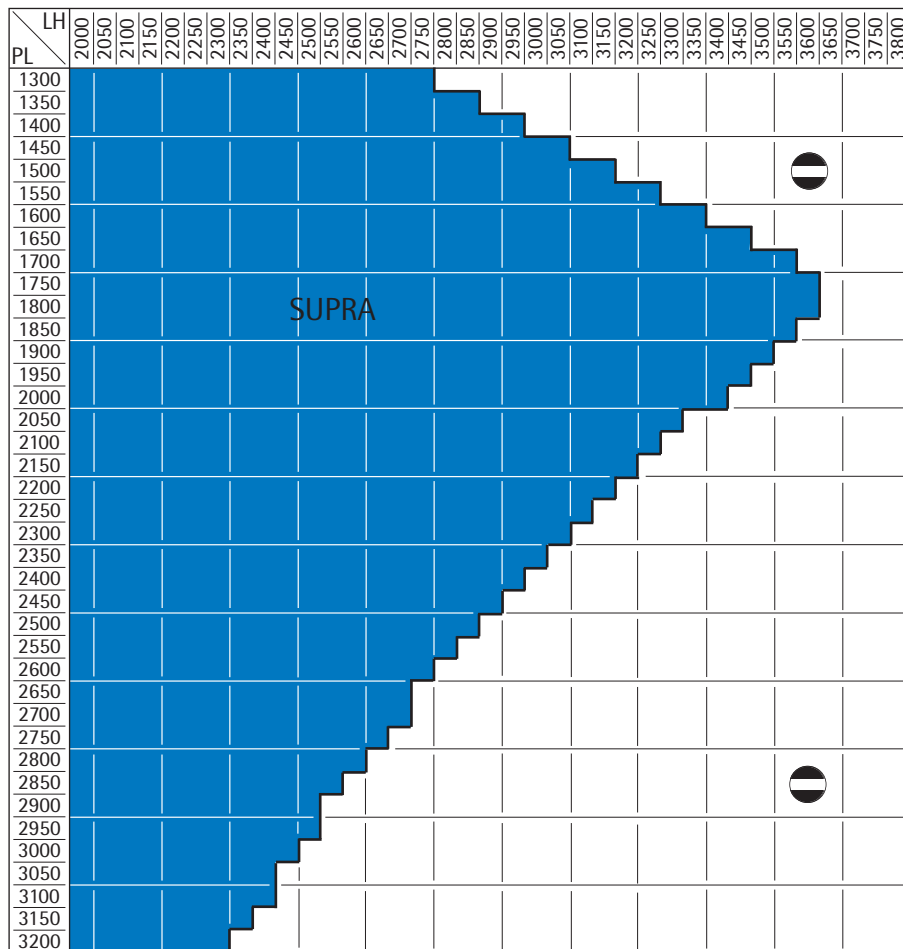

TY 42/C

FOR TYPE 41/C LANDING DOORS WITH
GLASS AND GLASS-FRAMED PANELS
PER PORTE DI PIANO TIPO 41/C CON ANTE
IN VETRO E VETRATE

MAX. ALLOWABLE WEIGHT PESO MASSIMO AMMISSIBILE Landing and Car Door Panels Ante di cabina e ante di piano	
DRIVE MOTORIZZAZIONE	kg
SUPRA	700

 NOT FEASIBLE DOORS
PORTE NON FATTIBILI

CAR DOOR PEGASUS PLUS PORTE DI CABINA PEGASUS PLUS

MIDI-SUPRA DRIVE APPLICATION RANGE

TABELLA APPLICAZIONE MOTORIZZAZIONE MIDI-SUPRA

GLASS AND GLASS-FRAMED PANELS

ANTE IN VETRO E VETRATE

Code/Codice TC.2.001999.EN
Version/Versione /

Code/Codice 3214.30.0600V01
Version/Versione B

Date/Data 12.10.2010
Page/Pagina 1.4.2

LH \ PL	2000	2050	2100	2150	2200	2250	2300	2350	2400	2450	2500	2550	2600	2650	2700	2750	2800	2850	2900	2950	3000	3050	3100	3150	3200	3300	3350	3400	3450	3500	3550	3600	3650	3700	3750	3800	
1800																																					
1850																																					
1900																																					
1950																																					
2000																																					
2050																																					
2100																																					
2150																																					
2200																																					
2250																																					
2300																																					
2350																																					
2400																																					
2450																																					
2500																																					
2550																																					
2600																																					
2650																																					
2700																																					
2750																																					
2800																																					
2850																																					
2900																																					
2950																																					
3000																																					
3050																																					
3100																																					
3150																																					
3200																																					

TY 62/C

FOR TYPE 61/C LANDING DOORS WITH
GLASS AND GLASS-FRAMED PANELS
PER PORTE DI PIANO TIPO 61/C CON ANTE
IN VETRO E VETRATE

MAX. ALLOWABLE WEIGHT PESO MASSIMO AMMISSIBILE Landing and Car Door Panels Ante di cabina e ante di piano	
DRIVE MOTORIZZAZIONE	kg
SUPRA	700

 NOT FEASIBLE DOORS
PORTE NON FATTIBILI

LH \ PL	2000	2050	2100	2150	2200	2250	2300	2350	2400	2450	2500	2550	2600	2650	2700	2750	2800	2850	2900	2950	3000	3050	3100	3150	3200	3300	3350	3400	3450	3500	3550	3600	3650	3700	3750	3800	
600																																					
650																																					
700																																					
750																																					
800																																					
850																																					
900																																					
950																																					
1000																																					
1050																																					
1100																																					
1150																																					
1200																																					
1250																																					
1300																																					
1350																																					
1400																																					

TY 72/R-L

FOR TYPE 71/R-L LANDING DOORS WITH
GLASS AND GLASS-FRAMED PANELS
PER PORTE DI PIANO TIPO 71/R-L CON ANTE
IN VETRO E VETRATE

MAX. ALLOWABLE WEIGHT PESO MASSIMO AMMISSIBILE Landing and Car Door Panels Ante di cabina e ante di piano	
DRIVE MOTORIZZAZIONE	kg
MIDI	300
SUPRA	700

CAR DOOR PEGASUS PLUS PORTE DI CABINA PEGASUS PLUS

CAR DOOR OVERALL DIMENSIONS
DIMENSIONI D'INGOMBRO PORTA DI CABINA

Code/Codice TC.2.001999.EN
Version/Versione /

Code/Codice 3214.30.0600V01
Version/Versione A

Date/Data 12.10.2010
Page/Pagina 1.11

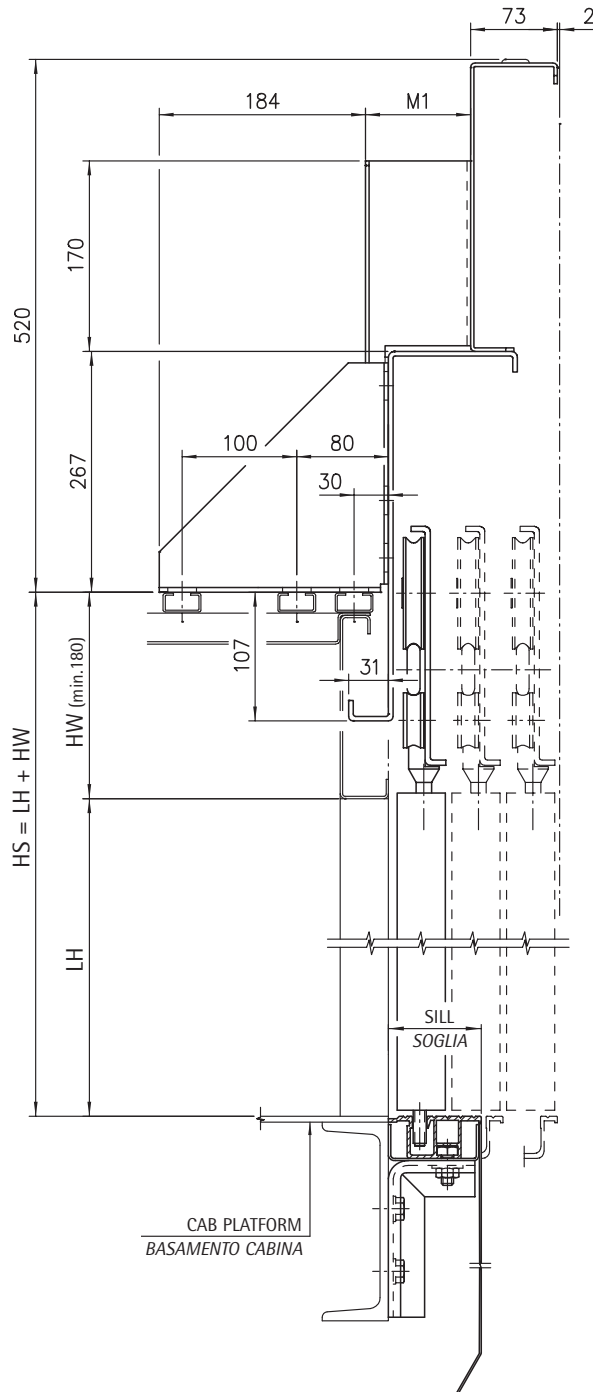

DOOR TYPE TIPO PORTA	M1	SILL SOGLIA
12/R-L	31	90
02/C	16	75
32/R-L	77	136
42/C	31	90
62/C	77	136
72/R-L	16	75

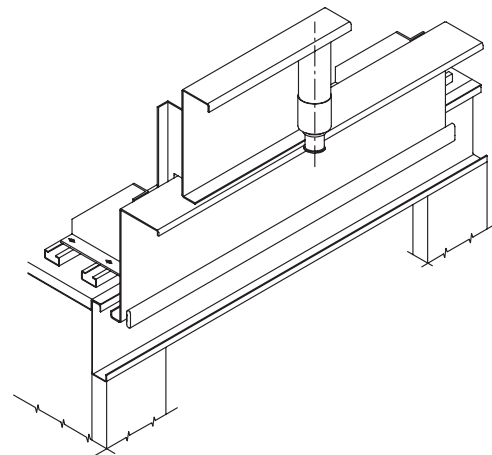



WITTUR

**CAR DOOR PEGASUS PLUS
PORTE DI CABINA PEGASUS PLUS**



Code/Codice TC.2.001999.EN
Version/Versione /

**OPENING AND CLOSING TIMES
TEMPI DI APERTURA E CHIUSURA**

Code/Codice 3214.30.0600V01
Version/Versione A
Date/Data 12.10.2010
Page/Pagina 1.12

**STANDARD AND FIRE TESTED "E" AND "EW" CLASS PANELS
ANTE STANDARD E RESISTENTI AL FUOCO CLASSI "E" ED "EW"**

TYPE TIPO	72/R-L			02/C			12/R-L			32/R-L			42/C			62/C		
	OPENING TIME TEMPO DI APERTURA	CLOSING TIME TEMPO DI CHIUSURA	CLOSING AVERAGE SPEED VELOCITA' MEDIA DI CHIUSURA m/s	OPENING TIME TEMPO DI APERTURA	CLOSING TIME TEMPO DI CHIUSURA	CLOSING AVERAGE SPEED VELOCITA' MEDIA DI CHIUSURA m/s	OPENING TIME TEMPO DI APERTURA	CLOSING TIME TEMPO DI CHIUSURA	CLOSING AVERAGE SPEED VELOCITA' MEDIA DI CHIUSURA m/s	OPENING TIME TEMPO DI APERTURA	CLOSING TIME TEMPO DI CHIUSURA	CLOSING AVERAGE SPEED VELOCITA' MEDIA DI CHIUSURA m/s	OPENING TIME TEMPO DI APERTURA	CLOSING TIME TEMPO DI CHIUSURA	CLOSING AVERAGE SPEED VELOCITA' MEDIA DI CHIUSURA m/s	OPENING TIME TEMPO DI APERTURA	CLOSING TIME TEMPO DI CHIUSURA	CLOSING AVERAGE SPEED VELOCITA' MEDIA DI CHIUSURA m/s
	s	s		s	s		s	s		s	s		s	s		s	s	
600	1,9	3,4																
650	2,0	3,6																
700	2,1	3,8																
750	2,2	4,0		1,6	2,5													
800	2,2	4,1		1,7	2,6		2,3	4,1										
850	2,3	4,3		1,7	2,7		2,4	4,3										
900	2,4	4,5		1,7	2,8		2,5	4,5		2,5	4,5							
950	2,5	4,7		1,8	2,9		2,6	4,4		2,6	4,7							
1000	2,6	4,9	0,26	1,8	2,9		2,6	4,9		2,6	4,9							
1050	2,7	5,1		1,9	3,0		2,7	5,2		2,7	5,1							
1100	2,8	5,3		1,9	3,1		2,8	5,3		2,8	5,3							
1150	2,9	5,5		2,0	3,2		2,9	5,5		2,9	5,5							
1200	2,9	5,7		2,0	3,3		2,9	5,7		2,9	5,7							
1250	3,0	5,9		2,1	3,4	0,26	3,0	5,9	0,26	3,0	5,9							
1300	3,1	6,0		2,1	3,5		3,1	6,0		3,1	6,0		2,1	3,5				
1350	3,2	6,2		2,2	3,6		3,2	6,2		3,2	6,2		2,2	3,6				
1400	3,3	6,4		2,2	3,7		3,3	6,4		3,3	6,4	0,26	2,2	3,7				
1450				2,2	3,8		3,4	6,6		3,4	6,6	0,26	2,2	3,8				
1500				2,2	3,9		3,5	6,8		3,5	6,8		2,2	3,9				
1550				2,3	4,0		3,6	7,0		3,6	7,0		2,3	4,0				
1600				2,3	4,1		3,6	7,2		3,6	7,2		2,3	4,1				
1650				2,4	4,2		3,7	7,4		3,7	7,4		2,4	4,2				
1700				2,4	4,3		3,8	7,6		3,8	7,6		2,4	4,3				
1750				2,5	4,4		3,9	7,8		3,9	7,8		2,5	4,4	0,26			
1800				2,5	4,5		4,0	8,0		4,0	8,0		2,5	4,5		2,5	4,5	
1850										4,1	8,2		2,6	4,6		2,6	4,6	
1900										4,2	8,3		2,6	4,7		2,6	4,7	
1950										4,3	8,5		2,7	4,8		2,7	4,8	
2000										3,6	11,8	0,18	2,7	4,9		2,7	4,9	0,26
2050										3,7	12,1		2,7	5,0		2,7	5,0	
2100										3,7	12,3		2,7	5,1		2,7	5,1	
2150													2,8	5,2		2,8	5,2	
2200													2,8	5,3		2,8	5,3	
2250													2,9	5,4		2,6	7,0	
2300													2,6	7,1		2,6	7,1	
2350													2,7	7,3		2,7	7,3	
2400													2,7	7,4		2,7	7,4	
2450													2,7	7,6		2,7	7,6	
2500													2,7	7,7		2,7	7,7	
2550													2,8	7,9		2,8	7,9	
2600													2,8	8,0		2,8	8,0	
2650													2,8	8,1		2,8	8,1	
2700													2,8	8,2		2,8	8,2	
2750													2,9	8,4	0,18	2,9	8,4	0,18
2800													2,9	8,5		2,9	8,5	
2850													2,9	8,7		2,9	8,7	
2900													2,9	8,8		2,9	8,8	
2950													3,0	9,0		3,0	9,0	
3000													3,0	9,1		3,0	9,1	
3050													3,0	9,2		3,0	9,2	
3100													3,0	9,3		3,0	9,3	
3150													3,1	9,5		3,1	9,5	
3200													3,1	9,6		3,1	9,6	

 MIDI
 SUPRA

THE DIVISION OF THE MIDI-SUPRA
 DRIVE SHOWN IN THE SCHEDULE
 IS VALID ONLY FOR LH=2000
 LA SUDDIVISIONE TRA LE MOTORIZZAZIONI
 MIDI-SUPRA INDICATA IN TABELLA E'
 VALIDA SOLO PER LH=2000



CAR DOOR PEGASUS PLUS
PORTE DI CABINA PEGASUS PLUS



Code/Codice TC.2.001999.EN
Version/Versione /

Code/Codice 3214.30.0600V01
Version/Versione A

Date/Data 12.10.2010
Page/Pagina 1.13

OPENING AND CLOSING TIMES

TEMPI DI APERTURA E CHIUSURA

STANDARD AND FIRE TESTED "E" AND "EW" CLASS PANELS

ANTE STANDARD E RESISTENTI AL FUOCO CLASSI "E" ED "EW"

TYPE TIPO	72/R-L			02/C			12/R-L			32/R-L			42/C			62/C		
	OPENING TIME TEMPO DI APERTURA	CLOSING TIME TEMPO DI CHIUSURA	CLOSING AVERAGE SPEED VELOCITA' MEDIA DI CHIUSURA	OPENING TIME TEMPO DI APERTURA	CLOSING TIME TEMPO DI CHIUSURA	CLOSING AVERAGE SPEED VELOCITA' MEDIA DI CHIUSURA	OPENING TIME TEMPO DI APERTURA	CLOSING TIME TEMPO DI CHIUSURA	CLOSING AVERAGE SPEED VELOCITA' MEDIA DI CHIUSURA	OPENING TIME TEMPO DI APERTURA	CLOSING TIME TEMPO DI CHIUSURA	CLOSING AVERAGE SPEED VELOCITA' MEDIA DI CHIUSURA	OPENING TIME TEMPO DI APERTURA	CLOSING TIME TEMPO DI CHIUSURA	CLOSING AVERAGE SPEED VELOCITA' MEDIA DI CHIUSURA	OPENING TIME TEMPO DI APERTURA	CLOSING TIME TEMPO DI CHIUSURA	CLOSING AVERAGE SPEED VELOCITA' MEDIA DI CHIUSURA
	s	s	m/s	s	s	m/s	s	s	m/s	s	s	m/s	s	s	m/s	s	s	m/s
600	1,9																	
650	2,0	4,0	*															
700	2,1																	
750	2,2	4,0		1,6														
800	2,2	4,1		1,7			2,3	4,1										
850	2,3	4,3		1,7			2,4	4,3										
900	2,4	4,5		1,7			2,5	4,5				2,5	4,5					
950	2,5	4,7		1,8			2,6	4,4				2,6	4,7					
1000	2,6	4,9	0,26	1,8			2,6	4,9				2,6	4,9					
1050	2,7	5,1		1,9			2,7	5,2				2,7	5,1					
1100	2,8	5,3		1,9			2,8	5,3				2,8	5,3					
1150	2,9	5,5		2,0	4,0	*	2,9	5,5				2,9	5,5					
1200	2,9	5,7		2,0			2,9	5,7				2,9	5,7					
1250	3,0	5,9		2,1			3,0	5,9	0,26			3,0	5,9					
1300	3,1	6,0		2,1			3,1	6,0				3,1	6,0	2,1				
1350	3,2	6,2		2,2			3,2	6,2				3,2	6,2	2,2				
1400	3,3	6,4		2,2			3,3	6,4				3,3	6,4	2,2	4,0	*		
1450				2,2			3,4	6,6			0,26	3,4	6,6	2,2				
1500				2,2			3,5	6,8				3,5	6,8	2,2				
1550				2,3	4,0		3,6	7,0				3,6	7,0	2,3	4,0			
1600				2,3	4,1		3,6	7,2				3,6	7,2	2,3	4,1			
1650				2,4	4,2		3,7	7,4				3,7	7,4	2,4	4,2			
1700				2,4	4,3	0,26	3,8	7,6				3,8	7,6	2,4	4,3			
1750				2,5	4,4		3,9	7,8				3,9	7,8	2,5	4,4			
1800				2,5	4,5		4,0	8,0				4,0	8,0	2,5	4,5	2,5	4,5	
1850												4,1	8,2	2,6	4,6	2,6	4,6	
1900												4,2	8,3	2,6	4,7	2,6	4,7	0,26
1950												4,3	8,5	2,7	4,8	2,7	4,8	
2000												3,6	11,8	2,7	4,9	2,7	4,9	0,26
2050												3,7	12,1	2,7	5,0	2,7	5,0	
2100												3,7	12,3	2,7	5,1	2,7	5,1	
2150														2,8	5,2	2,8	5,2	
2200														2,8	5,3	2,8	5,3	
2250														2,9	5,4	2,6	7,0	
2300														2,6	7,1	2,6	7,1	
2350														2,7	7,3	2,7	7,3	
2400														2,7	7,4	2,7	7,4	
2450														2,7	7,6	2,7	7,6	
2500														2,7	7,7	2,7	7,7	
2550														2,8	7,9	2,8	7,9	
2600														2,8	8,0	2,8	8,0	
2650														2,8	8,1	2,8	8,1	
2700														2,8	8,2	2,8	8,2	
2750														2,9	8,4	2,9	8,4	0,18
2800														2,9	8,5	2,9	8,5	
2850														2,9	8,7	2,9	8,7	
2900														2,9	8,8	2,9	8,8	
2950														3,0	9,0	3,0	9,0	
3000														3,0	9,1	3,0	9,1	
3050														3,0	9,2	3,0	9,2	
3100														3,0	9,3	3,0	9,3	
3150														3,1	9,5	3,1	9,5	
3200														3,1	9,6	3,1	9,6	

DEPENDENT ON CLOSING TIME (min. 4 sec.)
* SUBORDINATA AL TEMPO DI CHIUSURA (min. 4 sec.)

MIDI
SUPRA

THE DIVISION OF THE MIDI-SUPRA DRIVE SHOWN IN THE SCHEDULE IS VALID ONLY FOR LH=2000
LA SUDDIVISIONE TRA LE MOTORIZZAZIONI MIDI-SUPRA INDICATA IN TABELLA E' VALIDA SOLO PER LH=2000



CAR DOOR PEGASUS PLUS
PORTE DI CABINA PEGASUS PLUS



Code/Codice TC.2.001999.EN
Version/Versione /

OPENING AND CLOSING TIMES
TEMPI DI APERTURA E CHIUSURA

Code/Codice 3214.30.0600V01
Version/Versione A
Date/Data 12.10.2010
Page/Pagina 1.14

FIRE TESTED "EI" CLASS PANELS
ANTE RESISTENTI AL FUOCO CLASSE "EI"

TYPE TIPO	72/R-L			02/C			12/R-L			32/R-L			42/C			62/C		
	OPENING TIME TEMPO DI APERTURA	CLOSING TIME TEMPO DI CHIUSURA	CLOSING AVERAGE SPEED VELOCITA' MEDIA DI CHIUSURA	OPENING TIME TEMPO DI APERTURA	CLOSING TIME TEMPO DI CHIUSURA	CLOSING AVERAGE SPEED VELOCITA' MEDIA DI CHIUSURA	OPENING TIME TEMPO DI APERTURA	CLOSING TIME TEMPO DI CHIUSURA	CLOSING AVERAGE SPEED VELOCITA' MEDIA DI CHIUSURA	OPENING TIME TEMPO DI APERTURA	CLOSING TIME TEMPO DI CHIUSURA	CLOSING AVERAGE SPEED VELOCITA' MEDIA DI CHIUSURA	OPENING TIME TEMPO DI APERTURA	CLOSING TIME TEMPO DI CHIUSURA	CLOSING AVERAGE SPEED VELOCITA' MEDIA DI CHIUSURA	OPENING TIME TEMPO DI APERTURA	CLOSING TIME TEMPO DI CHIUSURA	CLOSING AVERAGE SPEED VELOCITA' MEDIA DI CHIUSURA
	s	s	m/s	s	s	m/s	s	s	m/s	s	s	m/s	s	s	m/s	s	s	m/s
600	1,9	3,4																
650	2,0	3,6																
700	2,1	3,8																
750	2,2	4,0																
800	2,2	4,1		1,6	2,5		2,3	4,1										
850	2,3	4,3		1,7	2,6		2,4	4,3										
900	2,4	4,5		1,7	2,7		2,4	4,3										
950	2,4	4,5		1,7	2,7		2,5	4,5										
950	2,5	4,7		1,8	2,9		2,6	4,4		2,5	4,5							
1000	2,6	4,9	0,26	1,8	2,9		2,6	4,4		2,6	4,7							
1000	2,6	4,9		1,8	2,9		2,6	4,4		2,6	4,9							
1050	2,7	5,1		1,9	3,0		2,7	5,2		2,7	5,1							
1100	2,8	5,3		1,9	3,1		2,7	5,2		2,7	5,1							
1100	2,8	5,3		1,9	3,1		2,8	5,3		2,8	5,3							
1150	2,9	5,5		2,0	3,2		2,8	5,3		2,8	5,3							
1150	2,9	5,5		2,0	3,2		2,9	5,5		2,9	5,5							
1200	2,9	5,7		2,0	3,3		2,9	5,7		2,9	5,7							
1200	2,9	5,7		2,0	3,3		2,9	5,7		2,9	5,7							
1250	3,0	5,9		2,1	3,4		2,9	5,7		2,9	5,7							
1250	3,0	5,9		2,1	3,4	0,26	3,0	5,9	0,26	3,0	5,9							
1300	3,1	6,0		2,1	3,5		3,1	6,0		3,1	6,0							
1300	3,1	6,0		2,1	3,5		3,1	6,0		3,1	6,0							
1350	3,2	6,2		2,2	3,6		3,2	6,2		3,2	6,2							
1350	3,2	6,2		2,2	3,6		3,2	6,2		3,2	6,2							
1400	3,3	6,4		2,2	3,7		3,3	6,4		3,3	6,4							
1400	3,3	6,4		2,2	3,7		3,3	6,4		3,3	6,4							
1450				2,2	3,8		3,4	6,6		3,4	6,6							
1450				2,2	3,8		3,4	6,6		3,4	6,6							
1500				2,2	3,9		3,5	6,8		3,5	6,8	0,26						
1500				2,2	3,9		3,5	6,8		3,5	6,8	0,26						
1550				2,3	4,0		3,6	7,0		3,6	7,0							
1550				2,3	4,0		3,6	7,0		3,6	7,0							
1600				2,3	4,1		3,6	7,2		3,6	7,2							
1600				2,3	4,1		3,6	7,2		3,6	7,2							
1650				2,4	4,2		3,7	7,4		3,7	7,4							
1650				2,4	4,2		3,7	7,4		3,7	7,4							
1700				2,4	4,3		3,8	7,6		3,8	7,6							
1700				2,4	4,3		3,8	7,6		3,8	7,6							
1750				2,5	4,4		3,9	7,8		3,9	7,8							
1750				2,5	4,4		3,9	7,8		3,9	7,8							
1800				2,5	4,5		4,0	8,0		4,0	8,0							
1800				2,5	4,5		4,0	8,0		4,0	8,0							
1850							4,1	8,2		4,1	8,2							
1850							4,1	8,2		4,1	8,2							
1900							4,2	8,3		4,2	8,3							
1900							4,2	8,3		4,2	8,3							
1950							4,3	8,5		4,3	8,5							
1950							4,3	8,5		4,3	8,5							
2000							4,3	8,7		4,3	8,7							
2000							4,3	8,7		4,3	8,7							
2050							4,4	8,9		4,4	8,9							
2050							4,4	8,9		4,4	8,9							
2100							4,5	9,1		4,5	9,1							
2100							4,5	9,1		4,5	9,1							
2150																		
2150																		
2200																		
2200																		
2250																		
2250																		
2300																		
2300																		
2350																		
2350																		
2400																		
2400																		
2450																		
2450																		
2500																		
2500																		
2550																		
2550																		
2600																		
2600																		
2650																		
2650																		
2700																		
2700																		
2750																		
2750																		
2800																		
2800																		
2850																		
2850																		
2900																		
2900																		
2950																		
2950																		
3000																		
3000																		
3050																		
3050																		
3100																		
3100																		
3150																		
3150																		
3200																		
3200																		

 MIDI
 SUPRA

THE DIVISION OF THE MIDI-SUPRA
 DRIVE SHOWN IN THE SCHEDULE
 IS VALID ONLY FOR LH=2000
 LA SUDDIVISIONE TRA LE MOTORIZZAZIONI
 MIDI-SUPRA INDICATA IN TABELLA E'
 VALIDA SOLO PER LH=2000



WITTUR

CAR DOOR PEGASUS PLUS
PORTE DI CABINA PEGASUS PLUS



Code/Codice TC.2.001999.EN
Version/Versione /

Code/Codice 3214.30.0600V01
Version/Versione A

Date/Data 12.10.2010
Page/Pagina 1.15

OPENING AND CLOSING TIMES

TEMPI DI APERTURA E CHIUSURA

FIRE TESTED "EI" CLASS PANELS

ANTE RESISTENTI AL FUOCO CLASSE "EI"

TYPE TIPO	72/R-L			02/C			12/R-L			32/R-L			42/C			62/C		
	OPENING TIME TEMPO DI APERTURA	CLOSING TIME TEMPO DI CHIUSURA	CLOSING AVERAGE SPEED VELOCITA' MEDIA DI CHIUSURA	OPENING TIME TEMPO DI APERTURA	CLOSING TIME TEMPO DI CHIUSURA	CLOSING AVERAGE SPEED VELOCITA' MEDIA DI CHIUSURA	OPENING TIME TEMPO DI APERTURA	CLOSING TIME TEMPO DI CHIUSURA	CLOSING AVERAGE SPEED VELOCITA' MEDIA DI CHIUSURA	OPENING TIME TEMPO DI APERTURA	CLOSING TIME TEMPO DI CHIUSURA	CLOSING AVERAGE SPEED VELOCITA' MEDIA DI CHIUSURA	OPENING TIME TEMPO DI APERTURA	CLOSING TIME TEMPO DI CHIUSURA	CLOSING AVERAGE SPEED VELOCITA' MEDIA DI CHIUSURA	OPENING TIME TEMPO DI APERTURA	CLOSING TIME TEMPO DI CHIUSURA	CLOSING AVERAGE SPEED VELOCITA' MEDIA DI CHIUSURA
	s	s	m/s	s	s	m/s	s	s	m/s	s	s	m/s	s	s	m/s	s	s	m/s
600	1,9																	
650	2,0	4,0	*															
700	2,1																	
750	2,2	4,0																
800	2,2	4,1																
850	2,3	4,3																
900	2,4	4,5																
950	2,5	4,7																
1000	2,6	4,9	0,26															
1050	2,7	5,1																
1100	2,8	5,3																
1150	2,9	5,5		4,0	*													
1200	2,9	5,7																
1250	3,0	5,9																
1300	3,1	6,0						0,26										
1350	3,2	6,2																
1400	3,3	6,4																
1450																		
1500											0,26							
1550																		
1600																		
1650																		
1700						0,26												
1750																		
1800																		
1850																		
1900																		
1950																		
2000																		
2050																		
2100																		
2150																		
2200																		
2250																		
2300																		
2350																		
2400																		
2450																		
2500																		
2550																		
2600																		
2650																		
2700																		
2750																		
2800																		
2850																		
2900																		
2950																		
3000																		
3050																		
3100																		
3150																		
3200																		

DEPENDENT ON CLOSING TIME (min. 4 sec.)
* SUBORDINATA AL TEMPO DI CHIUSURA (min. 4 sec.)

MIDI
SUPRA

THE DIVISION OF THE MIDI-SUPRA DRIVE SHOWN IN THE SCHEDULE IS VALID ONLY FOR LH=2000
LA SUDDIVISIONE TRA LE MOTORIZZAZIONI MIDI-SUPRA INDICATA IN TABELLA E' VALIDA SOLO PER LH=2000



CAR DOOR PEGASUS PLUS
PORTE DI CABINA PEGASUS PLUS



Code/Codice TC.2.001999.EN
Version/Versione /

OPENING AND CLOSING TIMES
TEMPI DI APERTURA E CHIUSURA

Code/Codice 3214.30.0600V01
Version/Versione A
Date/Data 12.10.2010
Page/Pagina 1.15.1

GLASS AND GLASS-FRAMED PANELS
ANTE IN VETRO E VETRATE

TYPE TIPO	72/R-L			02/C			12/R-L			32/R-L			42/C			62/C		
	OPENING TIME TEMPO DI APERTURA	CLOSING TIME TEMPO DI CHIUSURA	CLOSING AVERAGE SPEED VELOCITA' MEDIA DI CHIUSURA m/s	OPENING TIME TEMPO DI APERTURA	CLOSING TIME TEMPO DI CHIUSURA	CLOSING AVERAGE SPEED VELOCITA' MEDIA DI CHIUSURA m/s	OPENING TIME TEMPO DI APERTURA	CLOSING TIME TEMPO DI CHIUSURA	CLOSING AVERAGE SPEED VELOCITA' MEDIA DI CHIUSURA m/s	OPENING TIME TEMPO DI APERTURA	CLOSING TIME TEMPO DI CHIUSURA	CLOSING AVERAGE SPEED VELOCITA' MEDIA DI CHIUSURA m/s	OPENING TIME TEMPO DI APERTURA	CLOSING TIME TEMPO DI CHIUSURA	CLOSING AVERAGE SPEED VELOCITA' MEDIA DI CHIUSURA m/s	OPENING TIME TEMPO DI APERTURA	CLOSING TIME TEMPO DI CHIUSURA	CLOSING AVERAGE SPEED VELOCITA' MEDIA DI CHIUSURA m/s
	s	s	m/s	s	s	m/s	s	s	m/s	s	s	m/s	s	s	m/s	s	s	m/s
600	1,9	3,4																
650	2,0	3,6																
700	2,1	3,8																
750	2,2	4,0																
800	2,2	4,1		1,6	2,5				2,3	4,1								
850	2,3	4,3		1,7	2,6				2,4	4,3								
900	2,4	4,5		1,7	2,7				2,5	4,5								
950	2,4	4,5		1,7	2,8				2,5	4,5								
950	2,5	4,7		1,8	2,9				2,6	4,7								
1000	2,6	4,9	0,26	1,8	2,9				2,6	4,9								
1050	2,7	5,1		1,9	3,0				2,7	5,2								
1100	2,8	5,3		1,9	3,1	0,26			2,8	5,3								
1150	2,9	5,5		2,0	3,2				2,9	5,5				0,26				
1200	2,9	5,7		2,0	3,3				2,9	5,7	0,26							
1250	3,0	5,9		2,1	3,4				3,0	5,9								
1300	3,1	6,0		2,1	3,5				3,1	6,0				2,1	4,4			
1350	3,2	6,2		2,2	3,6				3,2	6,2			2,1	4,6				
1400	3,3	6,4		2,2	3,7				3,3	6,4			2,1	4,7				
1450				2,2	3,8				3,4	6,6			2,2	4,8				
1500				2,2	4,9				3,5	6,8			2,2	4,9				
1550				2,3	5,0				3,6	7,0			2,2	5,1				
1600				2,3	5,2				3,6	7,2			2,2	5,2				
1650				2,4	5,3	0,18			3,7	7,4			2,3	5,4				
1700				2,4	5,5				3,8	7,6			2,3	5,5				
1750				2,5	5,6				3,9	7,8	0,18		2,3	5,7				
1800				2,5	5,8				4,0	8,0			2,3	5,8			2,3	5,8
1850									4,1	8,2			2,4	5,9			2,4	5,9
1900									4,2	8,3			2,4	6,0			2,4	6,0
1950									4,3	8,5			2,4	6,2			2,4	6,2
2000									3,6	11,8			2,4	6,3			2,4	6,3
2050									3,7	12,1			2,5	6,5			2,5	6,4
2100									3,7	12,3			2,5	6,6			2,5	6,6
2150													2,6	6,8			2,6	6,7
2200													2,6	6,9			2,6	6,9
2250													2,6	7,1	0,18		2,6	7,0
2300													2,6	7,1			2,6	7,1
2350													2,7	7,3			2,7	7,3
2400													2,7	7,4			2,7	7,4
2450													2,7	7,6			2,7	7,6
2500													2,7	7,7			2,7	7,7
2550													2,8	7,9			2,8	7,9
2600													2,8	8,0			2,8	8,0
2650													2,8	8,1			2,8	8,1
2700													2,8	8,2			2,8	8,2
2750													2,9	8,4			2,9	8,4
2800													2,9	8,5			2,9	8,5
2850													2,9	8,7			2,9	8,7
2900													2,9	8,8			2,9	8,8
2950													3,0	9,0			3,0	9,0
3000													3,0	9,1			3,0	9,1
3050													3,0	9,2			3,0	9,2
3100													3,0	9,3			3,0	9,3
3150													3,1	9,5			3,1	9,5
3200													3,1	9,6			3,1	9,6

 MIDI
 SUPRA

THE DIVISION OF THE MIDI-SUPRA
 DRIVE SHOWN IN THE SCHEDULE
 IS VALID ONLY FOR LH=2000
 LA SUDDIVISIONE TRA LE MOTORIZZAZIONI
 MIDI-SUPRA INDICATA IN TABELLA E'
 VALIDA SOLO PER LH=2000



CAR DOOR PEGASUS PLUS
PORTE DI CABINA PEGASUS PLUS



Code/Codice TC.2.001999.EN
Version/Versione /

OPENING AND CLOSING TIMES
TEMPI DI APERTURA E CHIUSURA

Code/Codice 3214.30.0600V01
Version/Versione A

Date/Data 12.10.2010
Page/Pagina 1.15.2

GLASS AND GLASS-FRAMED PANELS
ANTE IN VETRO E VETRATE

TYPE TIPO	72/R-L			02/C			12/R-L			32/R-L			42/C			62/C		
	OPENING TIME TEMPO DI APERTURA	CLOSING TIME TEMPO DI CHIUSURA	CLOSING AVERAGE SPEED VELOCITA' MEDIA DI CHIUSURA	OPENING TIME TEMPO DI APERTURA	CLOSING TIME TEMPO DI CHIUSURA	CLOSING AVERAGE SPEED VELOCITA' MEDIA DI CHIUSURA	OPENING TIME TEMPO DI APERTURA	CLOSING TIME TEMPO DI CHIUSURA	CLOSING AVERAGE SPEED VELOCITA' MEDIA DI CHIUSURA	OPENING TIME TEMPO DI APERTURA	CLOSING TIME TEMPO DI CHIUSURA	CLOSING AVERAGE SPEED VELOCITA' MEDIA DI CHIUSURA	OPENING TIME TEMPO DI APERTURA	CLOSING TIME TEMPO DI CHIUSURA	CLOSING AVERAGE SPEED VELOCITA' MEDIA DI CHIUSURA	OPENING TIME TEMPO DI APERTURA	CLOSING TIME TEMPO DI CHIUSURA	CLOSING AVERAGE SPEED VELOCITA' MEDIA DI CHIUSURA
	s	s	m/s	s	s	m/s	s	s	m/s	s	s	m/s	s	s	m/s	s	s	m/s
600	1,9																	
650	2,0	4,0	*															
700	2,1																	
750	2,2	4,0		1,6														
800	2,2	4,1		1,7			2,3	4,1										
850	2,3	4,3		1,7			2,4	4,3										
900	2,4	4,5		1,7			2,5	4,5					2,5	4,5				
950	2,5	4,7		1,8			2,6	4,4					2,6	4,7				
1000	2,6	4,9	0,26	1,8			2,6	4,9					2,6	4,9				
1050	2,7	5,1		1,9			2,7	5,2					2,7	5,1				
1100	2,8	5,3		1,9			2,8	5,3					2,8	5,3	0,26			
1150	2,9	5,5		2,0	4,0	*	2,9	5,5					2,9	5,5				
1200	2,9	5,7		2,0			2,9	5,7	0,26				2,9	5,7				
1250	3,0	5,9		2,1			3,0	5,9					3,0	5,9				
1300	3,1	6,0		2,1			3,1	6,0					3,1	6,0		2,1	4,4	
1350	3,2	6,2		2,2			3,2	6,2					3,2	6,2		2,1	4,6	
1400	3,3	6,4		2,2			3,3	6,4					3,3	6,4		2,1	4,7	
1450				2,2			3,4	6,6					3,4	6,6		2,2	4,8	
1500				2,2	4,9		3,5	6,8					3,5	6,8		2,2	4,9	
1550				2,3	5,0		3,6	7,0					3,6	7,0		2,2	5,1	
1600				2,3	5,2		3,6	7,2					3,6	7,2		2,2	5,2	
1650				2,4	5,3	0,18	3,2	10,1					3,7	7,4		2,3	5,4	
1700				2,4	5,5		3,3	10,4	0,18				3,8	7,6		2,3	5,5	
1750				2,5	5,6		3,3	10,6					3,9	7,8	0,18	2,3	5,7	
1800				2,5	5,8		3,4	10,9					4,0	8,0		2,3	5,8	
1850													4,1	8,2		2,4	5,9	
1900													4,2	8,3		2,4	6,0	
1950													4,3	8,5		2,4	6,2	
2000													3,6	11,8		2,4	6,3	
2050													3,7	12,1		2,5	6,5	
2100													3,7	12,3		2,5	6,6	
2150													2,6	6,8		2,6	6,7	
2200													2,6	6,9		2,6	6,9	
2250													2,6	7,1	0,18	2,6	7,0	
2300													2,6	7,1		2,6	7,1	
2350													2,7	7,3		2,7	7,3	
2400													2,7	7,4		2,7	7,4	
2450													2,7	7,6		2,7	7,6	
2500													2,7	7,7		2,7	7,7	0,18
2550													2,8	7,9		2,8	7,9	
2600													2,8	8,0		2,8	8,0	
2650													2,8	8,1		2,8	8,1	
2700													2,8	8,2		2,8	8,2	
2750													2,9	8,4		2,9	8,4	
2800													2,9	8,5		2,9	8,5	
2850													2,9	8,7		2,9	8,7	
2900													2,9	8,8		2,9	8,8	
2950													3,0	9,0		3,0	9,0	
3000													3,0	9,1		3,0	9,1	
3050													3,0	9,2		3,0	9,2	
3100													3,0	9,3		3,0	9,3	
3150													3,1	9,5		3,1	9,5	
3200													3,1	9,6		3,1	9,6	

DEPENDENT ON CLOSING TIME (min. 4 sec.)
* SUBORDINATA AL TEMPO DI CHIUSURA (min. 4 sec.)

MIDI
SUPRA

THE DIVISION OF THE MIDI-SUPRA DRIVE SHOWN IN THE SCHEDULE IS VALID ONLY FOR LH=2000
LA SUDDIVISIONE TRA LE MOTORIZZAZIONI MIDI-SUPRA INDICATA IN TABELLA E' VALIDA SOLO PER LH=2000

CAR DOOR PEGASUS PLUS

PORTE DI CABINA PEGASUS PLUS

Code/Codice TC.2.001999.EN
Version/Versione /

BOTTOM FIXINGS FOR CAR SILLS - SIDE OPENING CAR DOORS

FISSAGGI INFERIORI SOGLIE CABINA - PORTE DI CABINA AD APERTURA LATERALE

Code/Codice 3214.30.0600V01
Version/Versione A

Date/Data 12.10.2010
Page/Pagina 1.15.3

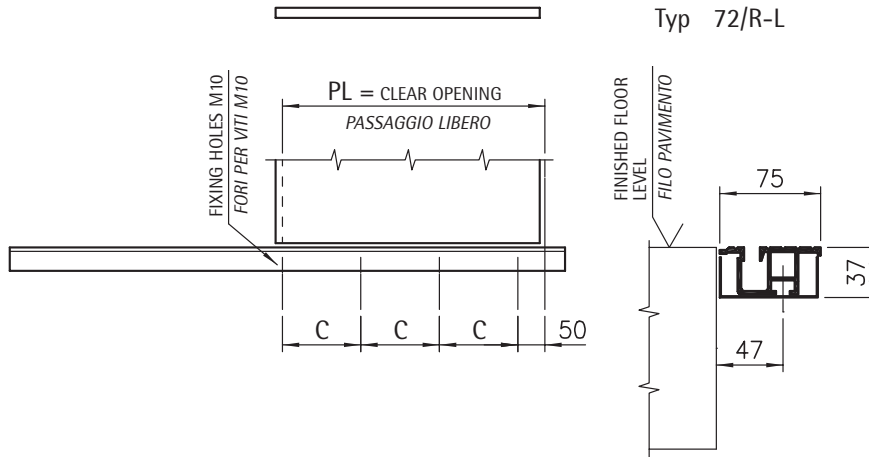

PL	C
600 ÷ 650	250
700	378
750 ÷ 800	400
850 ÷ 900	475
950 ÷ 1000	550
1050	483
1100	495
1150	508
1200	446
1250	456
1300	466
1350	476
1400	486

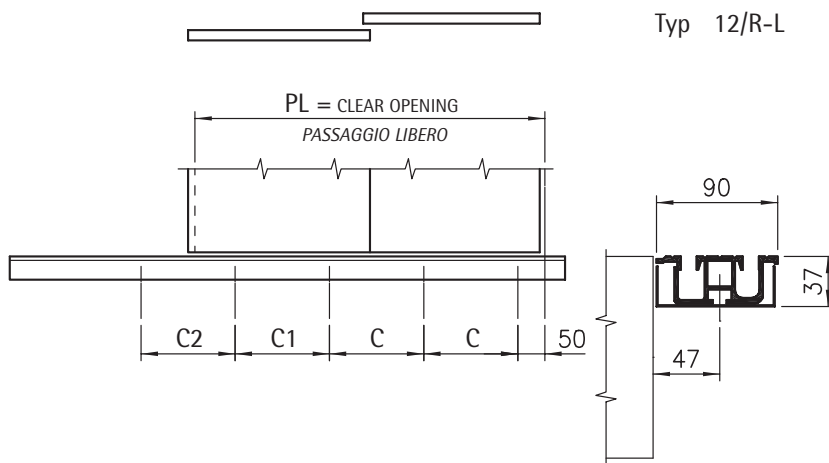

PL	C	C 1	C 2
800 ÷ 850	250	250	/
900 ÷ 1150	400	400	
1200 ÷ 1400	550	550	
1450	509	509	509
1500	520	520	520
1550	533	533	533
1600	545	545	545
1650	447	447	447
1700	457	457	457
1750	467	467	467
1800	509	509	509

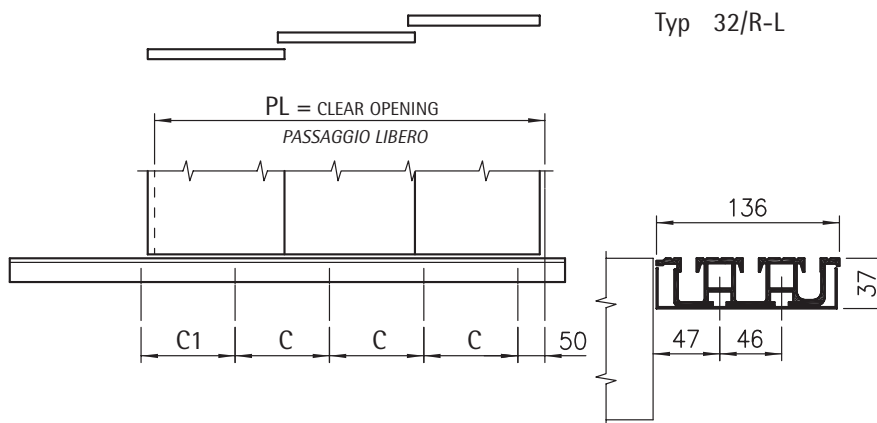

PL	C	C 1
900 ÷ 1000	325	/
1050 ÷ 1150	400	
1200 ÷ 1300	475	
1350 ÷ 1400	550	
1450	438	438
1500	450	450
1550	463	463
1600	475	475
1650	488	488
1700	500	500
1750	513	513
1800	450	450
1850	460	460
1900	470	470
1950	480	480
2000	490	490
2050	500	500
2100	510	510

CAR DOOR PEGASUS PLUS PORTE DI CABINA PEGASUS PLUS

Code/Codice TC.2.001999.EN
Version/Versione /

BOTTOM FIXINGS FOR CAR SILLS - CENTRE PARTING CAR DOORS FISSAGGI INFERIORI SOGLIE CABINA - PORTE CABINA AD APERTURA CENTRALE

Code/Codice 3214.30.0600V01
Version/Versione A
Date/Data 12.10.2010
Page/Pagina 1.15.4

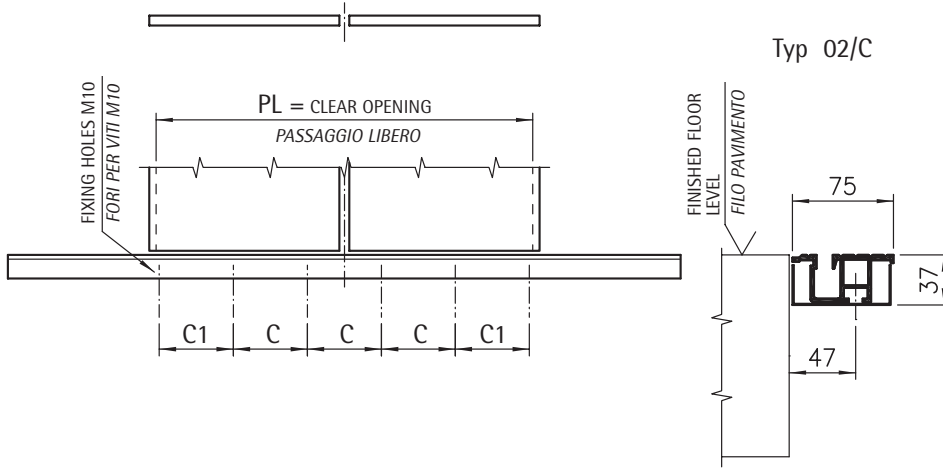

PL	C	C 1
750	250	
800 ÷ 1050	400	
1100 ÷ 1400	550	/
1450	542	
1500	552	
1550	562	
1600	409	409
1650	416	416
1700	423	423
1750	430	430
1800	483	483

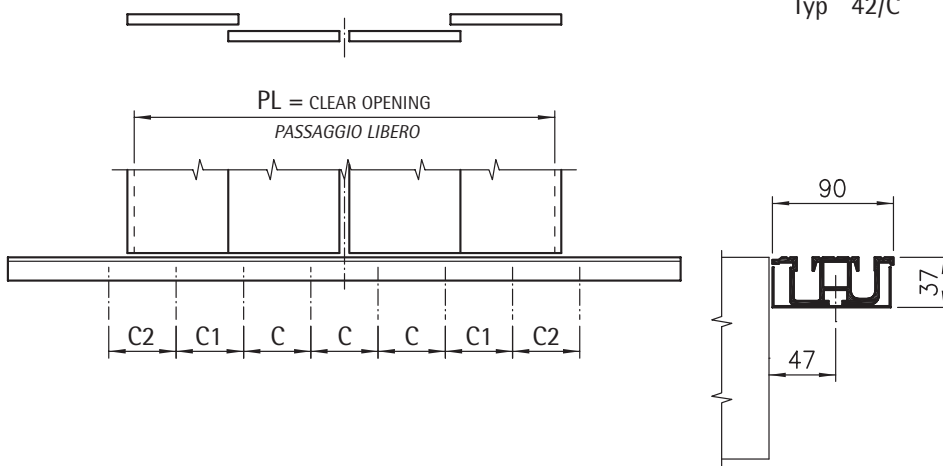

PL	C	C 1	C 2
1300 ÷ 1750	550		/
1800 ÷ 2350	500	500	
2400 ÷ 2800	486	486	
2850	428	428	428
2900	463	463	463
2950	469	469	469
3000	474	474	474
3050	480	480	480
3100	486	486	486
3150	491	491	491
3200	497	497	497

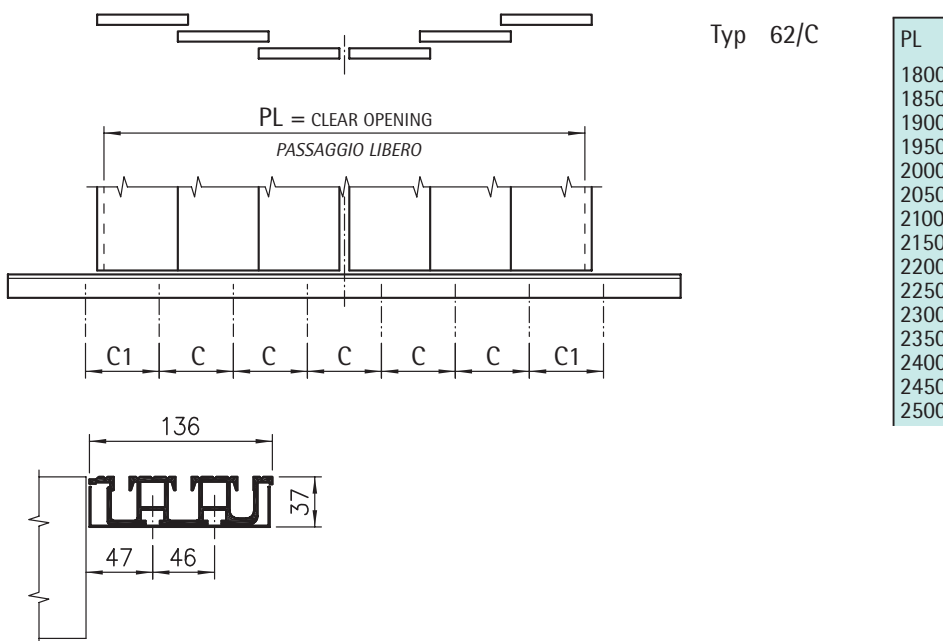

PL	C	C 1	PL	C	C 1
1800	440		2550	446	
1850	450		2600	453	
1900	460		2650	460	
1950	470		2700	486	/
2000	480		2750	493	
2050	490		2800	500	
2100	500		2850	394	
2150	510	/	2900	400	400
2200	520		2950	406	406
2250	530		3000	411	411
2300	410		3050	417	417
2350	417		3100	422	422
2400	424		3150	428	428
2450	431		3200	433	433
2500	439				

CAR DOOR PEGASUS PLUS PORTE DI CABINA PEGASUS PLUS

Code/Codice TC.2.001999.EN
Version/Versione /

CAR DOOR INFILL PANEL SCHEDULE

TABELLA DIMENSIONI COPRIFESSURA SUPERIORI

Code/Codice 3214.30.0600V01
Version/Versione A

Date/Data 12.10.2010
Page/Pagina 1.15.5

Dimensions valid only for painted or cladded (material thickness ≤ 1 mm) doors

Dimensioni valide solo per porte verniciate o rivestite con materiali di spessore ≤ 1 mm

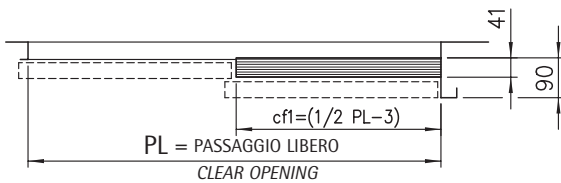

Typ 12/R-L

PL	cf 1	PL	cf 1
800	397	1350	672
850	422	1400	697
900	447	1450	722
950	472	1500	747
1000	497	1550	772
1050	522	1600	797
1100	547	1650	822
1150	572	1700	847
1200	597	1750	872
1250	622	1800	897
1300	647		

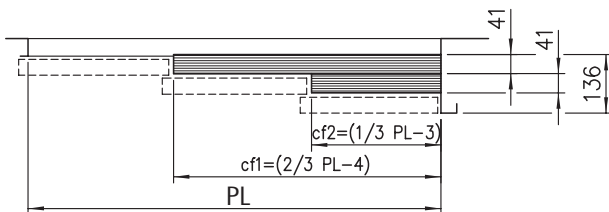

Typ 32/R-L

PL	cf 1	cf 2	PL	cf 1	cf 2
900	596	297	1550	1029	514
950	629	314	1600	1063	531
1000	663	331	1650	1096	547
1050	696	347	1700	1129	564
1100	729	364	1750	1163	581
1150	763	381	1800	1196	597
1200	796	397	1850	1229	614
1250	829	414	1900	1263	631
1300	863	431	1950	1296	647
1350	896	447	2000	1329	664
1400	929	464	2050	1363	681
1450	963	481	2100	1396	697
1500	996	497			

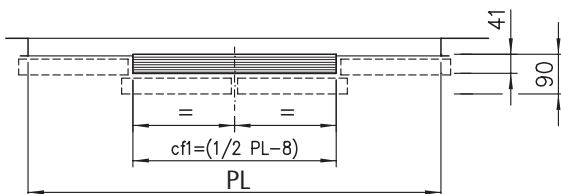

Typ 42/C

PL	cf 1	PL	cf 1	PL	cf 1
1300	642	1950	967	2600	1292
1350	667	2000	992	2650	1317
1400	692	2050	1017	2700	1342
1450	717	2100	1042	2750	1367
1500	742	2150	1067	2800	1392
1550	767	2200	1092	2850	1417
1600	792	2250	1117	2900	1442
1650	817	2300	1142	2950	1467
1700	842	2350	1167	3000	1492
1750	867	2400	1192	3050	1517
1800	892	2450	1217	3100	1542
1850	917	2500	1242	3150	1567
1900	942	2550	1267	3200	1592

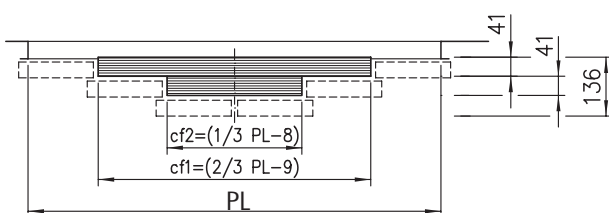

Typ 62/C

PL	cf 1	cf 2	PL	cf 1	cf 2
1800	1191	592	2550	1691	842
1850	1224	609	2600	1724	859
1900	1258	626	2650	1758	876
1950	1291	642	2700	1791	892
2000	1324	659	2750	1824	909
2050	1358	676	2800	1858	926
2100	1391	692	2850	1891	942
2150	1424	709	2900	1924	959
2200	1458	726	2950	1958	976
2250	1491	742	3000	1991	992
2300	1524	759	3050	2024	1009
2350	1558	776	3100	2058	1026
2400	1591	792	3150	2091	1042
2450	1624	809	3200	2124	1059
2500	1658	826			

CAR DOOR PEGASUS PLUS PORTE DI CABINA PEGASUS PLUS

Code/Codice TC.2.001999.EN
Version/Versione /

CAR DOOR INFILL PANEL SCHEDULE - DOORS WITH RUNBY

Code/Codice 3214.30.0600V01
Version/Versione A

TABELLA DIMENSIONI COPRIFESSURA SUPERIORI - PORTE CON EXTRACORSA

Date/Data 12.10.2010
Page/Pagina 1.15.6

Dimensions valid only for painted or cladded (material thickness ≤ 1 mm) doors

Dimensioni valide solo per porte verniciate o rivestite con materiali di spessore ≤ 1 mm

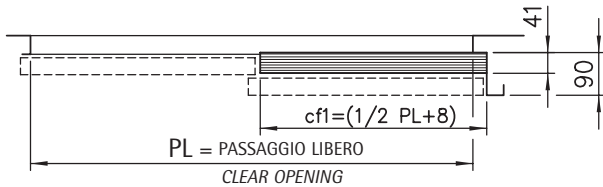

Typ 12/R-L

PL	cf 1	PL	cf 1
800	408	1350	683
850	433	1400	708
900	458	1450	733
950	483	1500	758
1000	508	1550	783
1050	533	1600	808
1100	558	1650	833
1150	583	1700	858
1200	608	1750	883
1250	633	1800	908
1300	658		

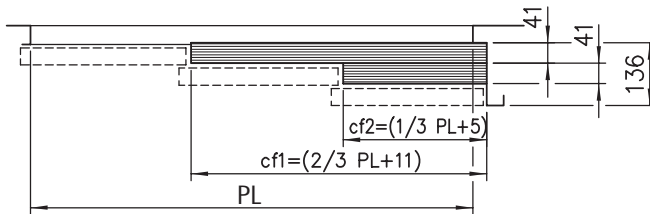

Typ 32/R-L

PL	cf 1	cf 2	PL	cf 1	cf 2
900	611	305	1550	1044	521
950	644	321	1600	1078	538
1000	678	338	1650	1111	555
1050	711	355	1700	1144	571
1100	744	371	1750	1178	588
1150	778	388	1800	1211	605
1200	811	405	1850	1244	621
1250	844	421	1900	1278	638
1300	878	438	1950	1311	655
1350	911	455	2000	1344	671
1400	944	471	2050	1378	688
1450	978	488	2100	1411	705
1500	1011	505			

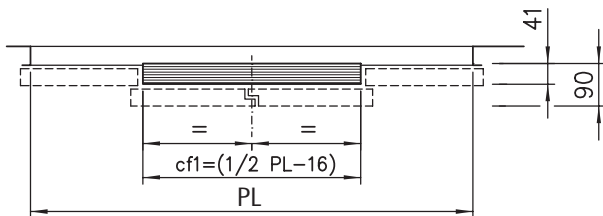

Typ 42/C

PL	cf 1	PL	cf 1	PL	cf 1
1300	634	1950	959	2600	1284
1350	659	2000	984	2650	1309
1400	684	2050	1009	2700	1334
1450	709	2100	1034	2750	1359
1500	734	2150	1059	2800	1384
1550	759	2200	1084	2850	1409
1600	784	2250	1109	2900	1434
1650	809	2300	1134	2950	1459
1700	834	2350	1159	3000	1484
1750	859	2400	1184	3050	1509
1800	884	2450	1209	3100	1534
1850	909	2500	1234	3150	1559
1900	934	2550	1259	3200	1584

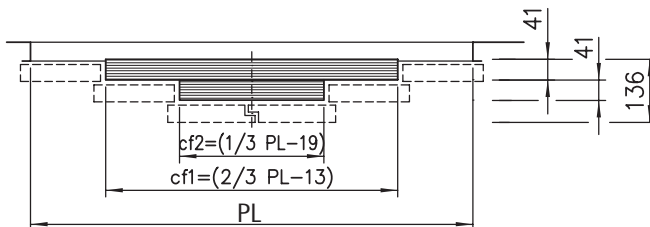

Typ 62/C

PL	cf 1	cf 2	PL	cf 1	cf 2
1800	1187	581	2550	1687	831
1850	1221	597	2600	1721	847
1900	1254	614	2650	1754	864
1950	1287	631	2700	1787	881
2000	1321	647	2750	1821	897
2050	1354	664	2800	1854	914
2100	1387	681	2850	1887	931
2150	1421	697	2900	1921	947
2200	1454	714	2950	1954	964
2250	1487	731	3000	1987	981
2300	1521	747	3050	2021	997
2350	1554	764	3100	2054	1014
2400	1587	781	3150	2087	1031
2450	1621	797	3200	2121	1047
2500	1654	814			

CAR DOOR PEGASUS PLUS
 PORTE DI CABINA PEGASUS PLUS

Code/Codice TC.2.001999.EN
 Version/Versione /

PEGASUS PLUS CAR DOORS AND PEGASUS LANDING DOORS ARRANGEMENT
 ACCOPPIAMENTO PORTE DI CABINA PEGASUS PLUS E PORTE DI PIANO PEGASUS

Code/Codice 3214.30.0600V01
 Version/Versione A
 Date/Data 12.10.2010
 Page/Pagina 1.16

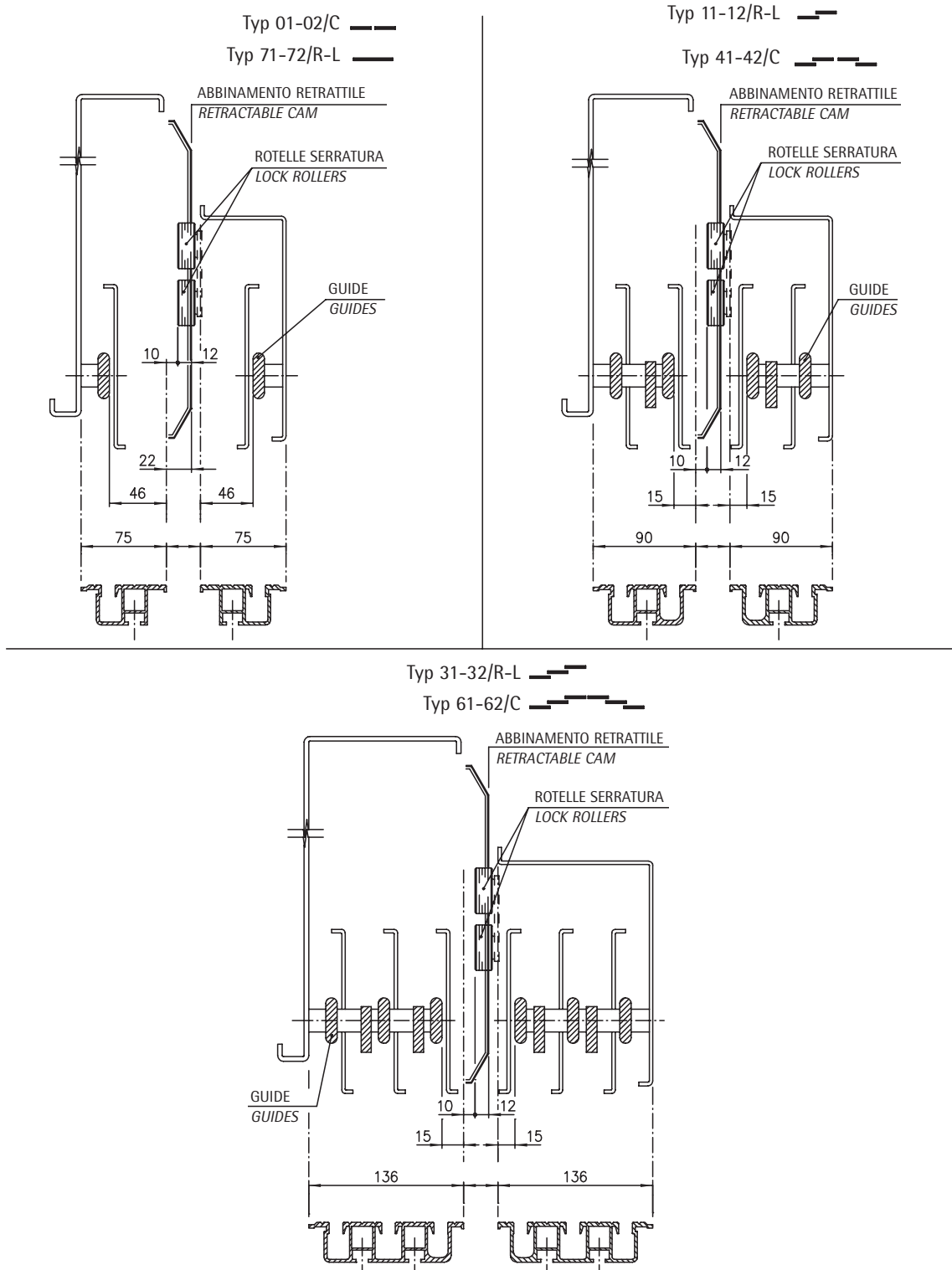

CAR DOOR PEGASUS PLUS
PORTE DI CABINA PEGASUS PLUS

Code/Codice TC.2.001999.EN
 Version/Versione /

CAR DOOR AND LANDING DOOR ARRANGEMENT WITH STANDARD COUPLER
ACCOPPIAMENTO PORTA DI CABINA E PORTA DI PIANO CON ABBINAMENTO STANDARD

Code/Codice 3214.30.0600V01
 Version/Versione B
 Date/Data 12.10.2010
 Page/Pagina 1.17

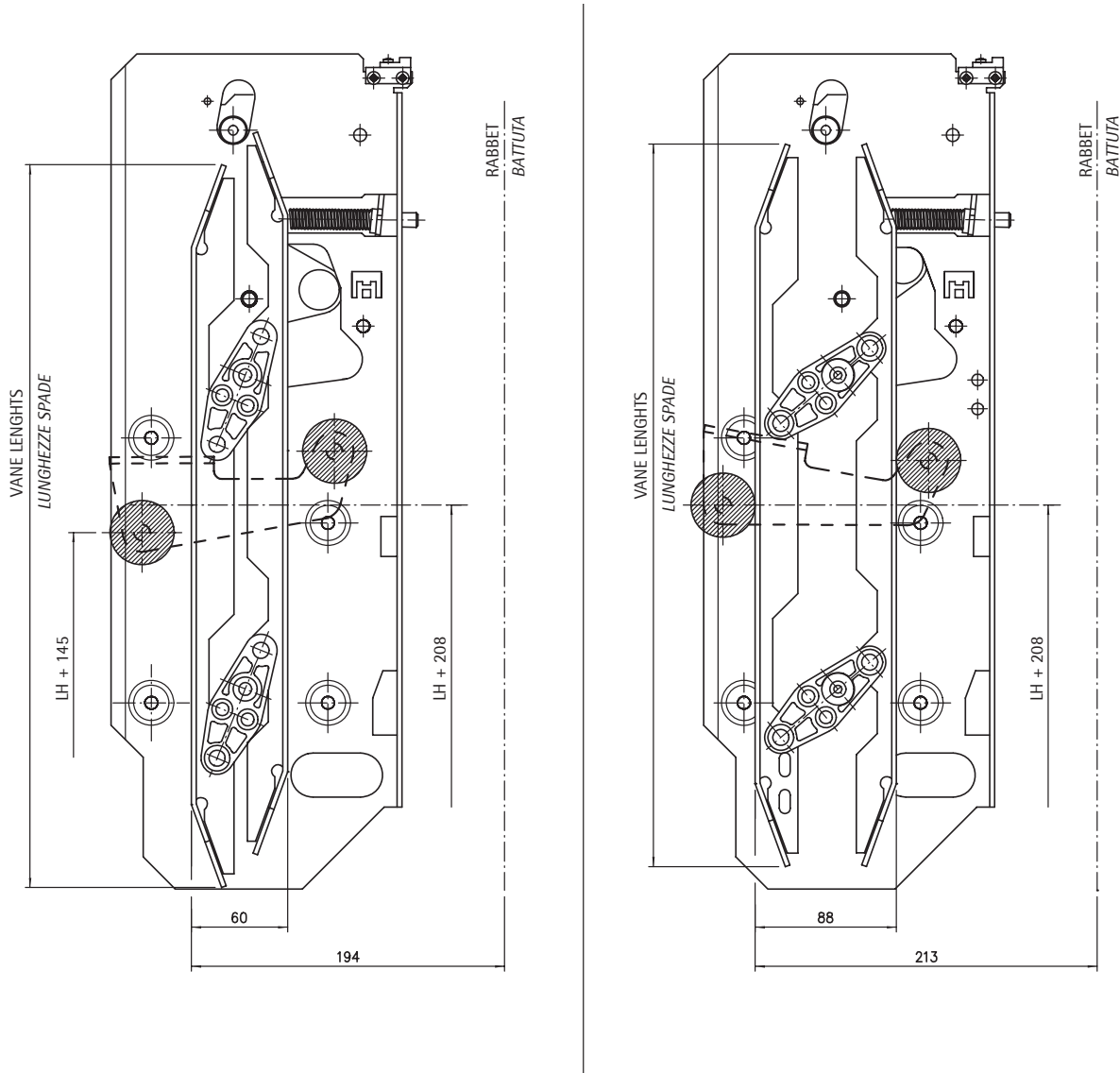

CAR SILL LINE
 FILO SOGLIA CABINA

LANDING SILL LINE
 FILO SOGLIA PIANO

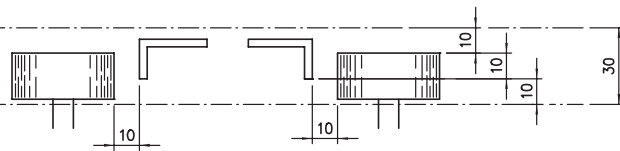

CLOSED VANES
 SPADE CHIUSE

CAR DOOR PEGASUS PLUS
PORTE DI CABINA PEGASUS PLUS

Code/Codice TC.2.001999.EN
 Version/Versione /

CAR DOOR AND LANDING DOOR ARRANGEMENT WITH COUPLER WITH CAR DOOR LOCK

Code/Codice 3214.30.0600V01
 Version/Versione B

ACCOPIAMENTO PORTA DI CABINA E PORTA DI PIANO CON ABBINAMENTO CON BLOCCAGGIO FUORI PIANO

Date/Data 12.10.2010
 Page/Pagina 1.18

Car stops in landing door zone:
 The rollers are detected. They operate
 the lock vane and the latch opens.

*Cabina ferma in zona porta di piano:
 Le rotelle sono rilevate. Esse liberano
 il blocco e il gancio si apre.*

Car stops out of landing door zone:
 No rollers are detected. The lock vane
 is not touched and the latch keeps closed.

*Cabina ferma fuori zona porta di piano:
 La spada non rileva le rotelle.
 Il gancio rimane chiuso.*

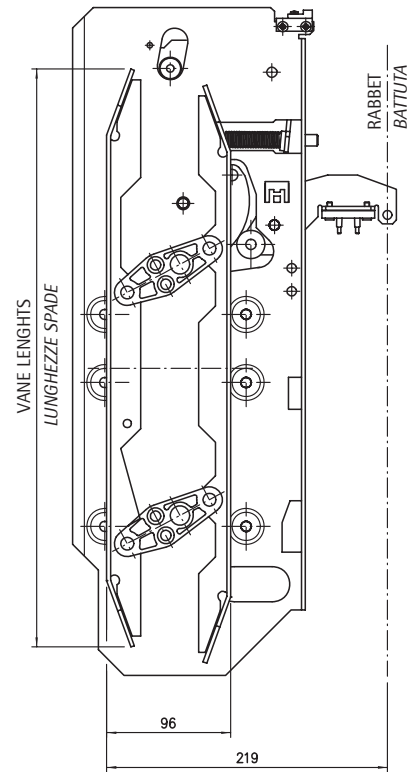
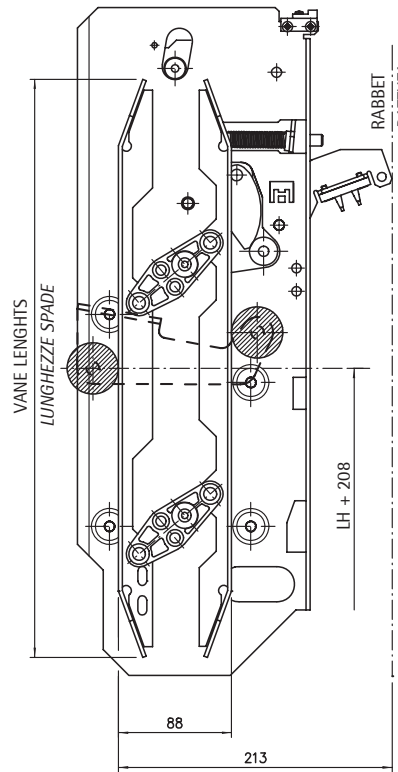
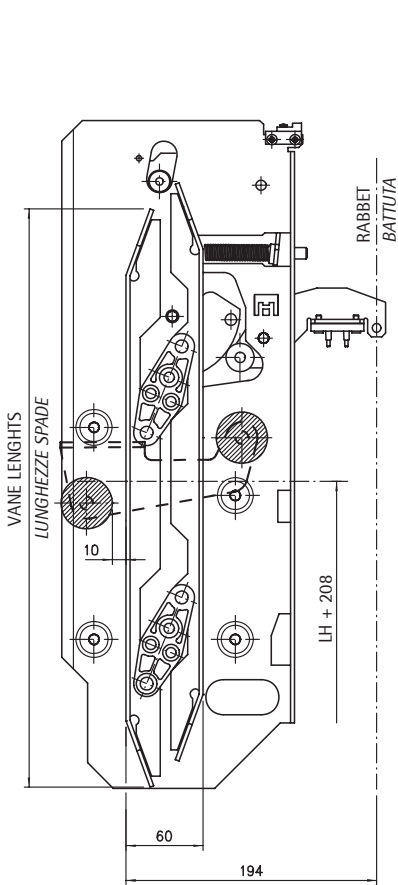

CAR SILL LINE
 FILO SOGLIA CABINA

LANDING SILL LINE
 FILO SOGLIA PIANO

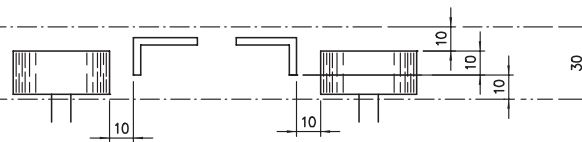

CLOSED VANES
 SPADE CHIUSE

CAR DOOR PEGASUS PLUS
PORTE DI CABINA PEGASUS PLUS

Code/Codice TC.2.001999.EN
Version/Versione /

EMERGENCY OPENING DEVICE FOR COUPLER WITH CAR DOOR LOCK
DISPOSITIVO DI APERTURA DI EMERGENZA CON ABBINAMENTO CON BLOCCAGGIO FUORI PIANO

Code/Codice 3214.30.0600V01
Version/Versione A
Date/Data 12.10.2010
Page/Pagina 1.19

STANDARD PANELS
ANTE STANDARD

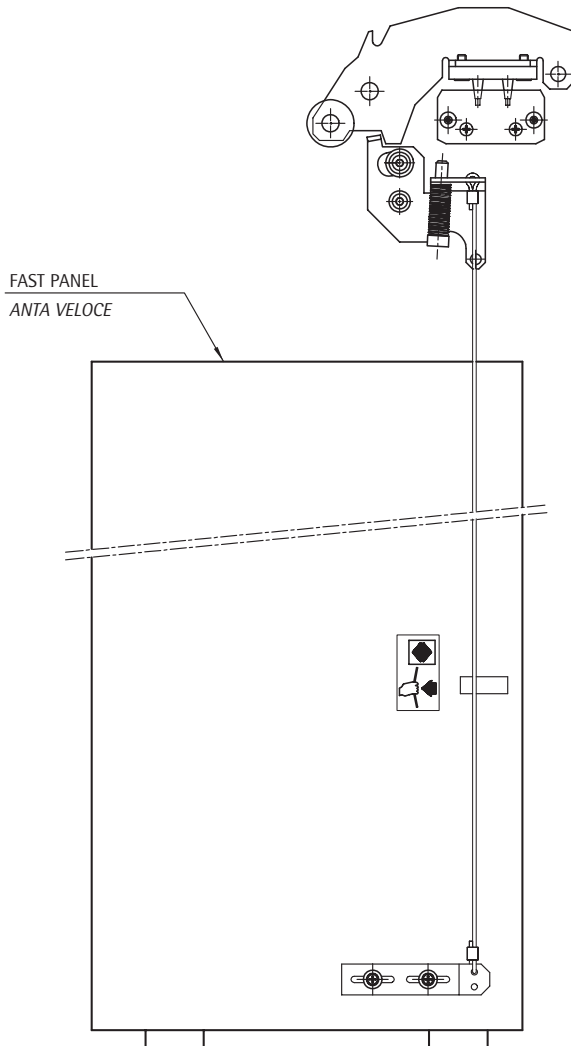

GLASS AND GLASS-FRAMED PANELS
ANTE IN VETRO E VETRATE

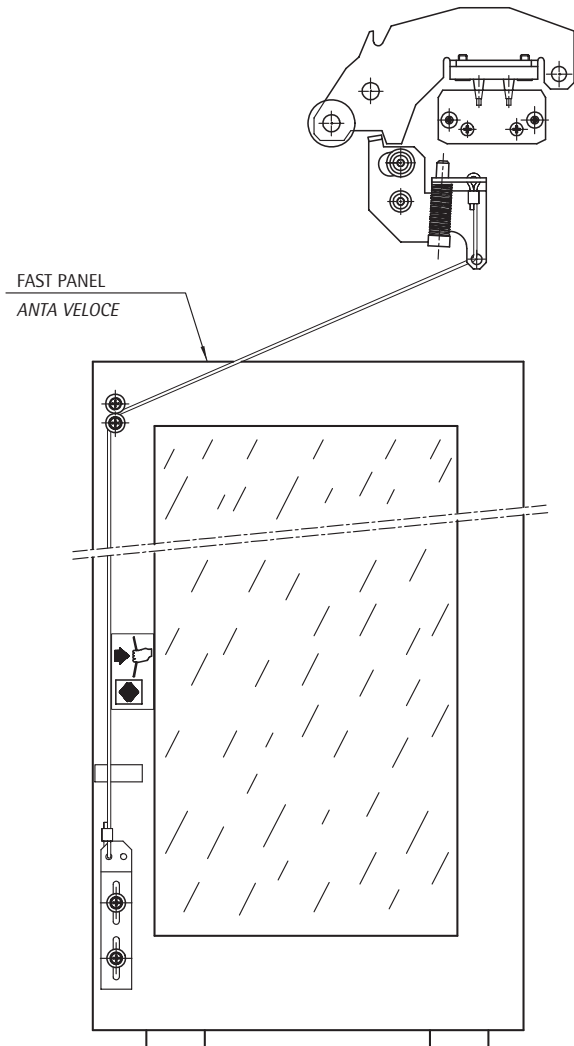

The rope of the car door emergency opening device is fixed to the bottom end of the door panel.
By pulling the rope, the car door lock is unlocked.

La fune del dispositivo di apertura di emergenza della porta di cabina è fissata all'estremità inferiore dell'anta. Tirando la fune la serratura della porta si sblocca.

CAR DOOR PEGASUS PLUS

PORTE DI CABINA PEGASUS PLUS

Code/Codice TC.2.001999.EN
Version/Versione /

TWO PANELS TELESCOPIC CAR DOOR, TYPE 12/R-L PL=800÷1800
PORTA DI CABINA TELESCOPICA 2 ANTE, TIPO 12/R-L PL=800÷1800

Code/Codice 3214.30.0600V01
Version/Versione A
Date/Data 12.10.2010
Page/Pagina 2.1

NOTE

WITH SEMI-AUTOMATIC TYPE SIZES DON'T CHANGE
CON IL MODELLO SEMIAUTOMATICO LE MISURE NON CAMBIANO

WITH C.D.L. DIMENSIONS DON'T CHANGE; DETAIL ON PAGE 1.18 AND 1.19
CON IL B.F.P. LE DIMENSIONI NON CAMBIANO; DETTAGLIO PAG. 1.18 E 1.19

A DETAIL ON PAGE 1.11
DETTAGLIO PAG. 1.11

FOR APPLICATION OF MIDI-SUPRA DRIVE SEE PAGE 1.2, 1.3, 1.4
APPLICAZIONE MOTORIZZAZIONE MIDI-SUPRA SECONDO PAGINE 1.2, 1.3, 1.4

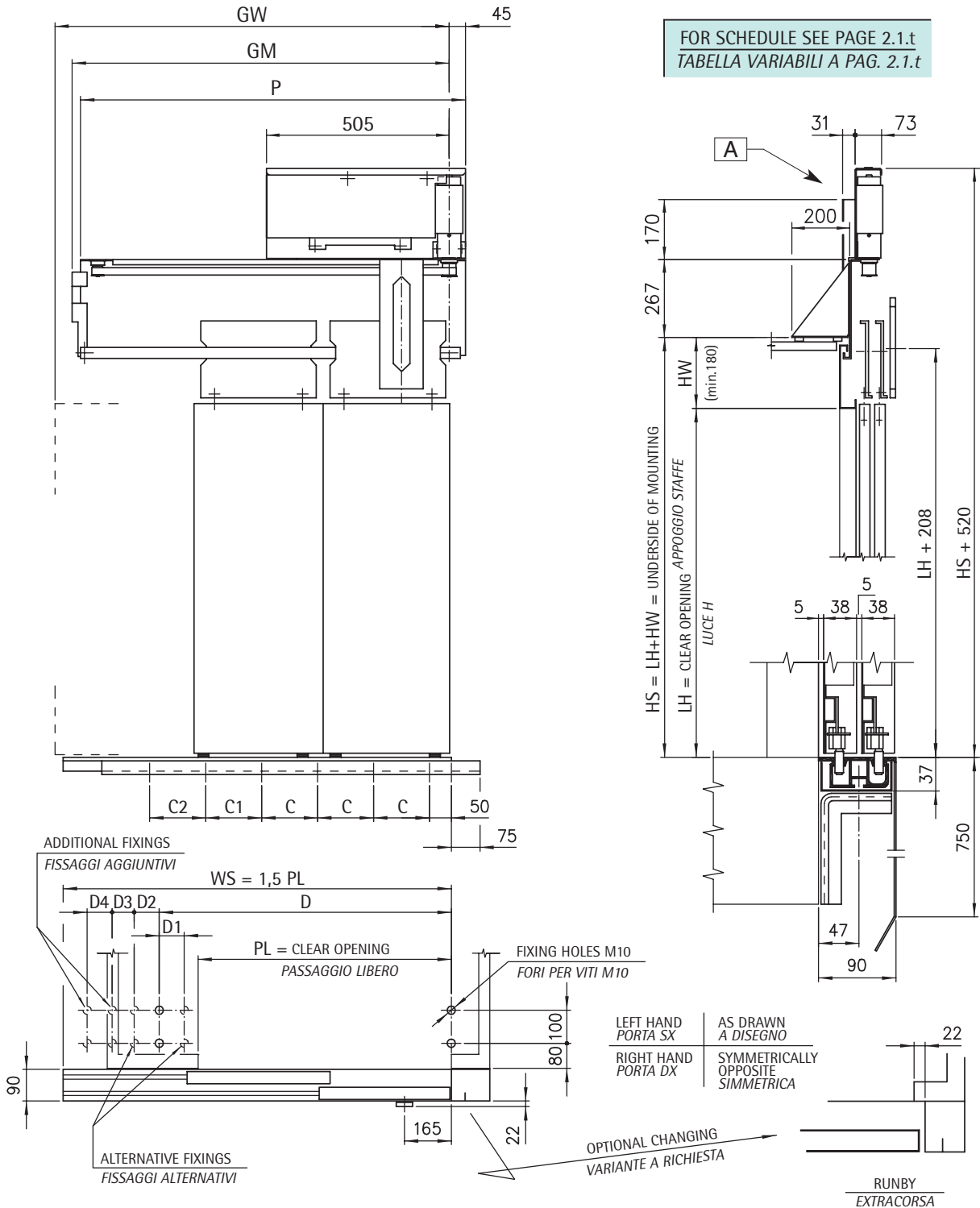



CAR DOOR PEGASUS PLUS
PORTE DI CABINA PEGASUS PLUS

Code/Codice TC.2.001999.EN
Version/Versione /

TWO PANELS TELESCOPIC CAR DOOR, TYPE 12/R-L PL=800÷1800
PORTA DI CABINA TELESCOPICA 2 ANTE, TIPO 12/R-L PL=800÷1800

Code/Codice 3214.30.0600V01
Version/Versione A
Date/Data 12.10.2010
Page/Pagina 2.1.t

	PL	C	C1	C2	D	D1	D2	D3	D4	GW	GM	P
*	800	250			912					1225	1210	1250
*	850						217	/		1300	1335	1375
*	900									1375	1385	1425
*	950									1450	1435	1475
*	1000	400			1137					1525	1560	1600
*	1050									1600	1610	1650
*	1100			/					/	1675	1660	1700
*	1150								1750	1785	1825	
*	1200								1825	1835	1875	
*	1250								1900	1885	1925	
*	1300	550			1362				/	1975	2010	2050
*	1350				/					2050	2060	2100
*	1400									2125	2110	2150
*	1450	509	509							2200	2235	2275
*	1500	520	520							2275	2285	2325
*	1550	533	533		1137					2350	2335	2375
*	1600	545	545			/	225			2425	2460	2500
*	1650	447	447							2500	2510	2550
*	1700	457	457							2575	2560	2600
*	1750	467	467							2650	2685	2725
*	1800	509	509		1362			500		2725	2735	2775

* ATTENTION: GM > GW
* ATTENZIONE: GM > GW

**FOR GLASS DOORS AND GLASS-FRAMED DOORS
ALWAYS USE REINFORCED OPERATORS**

*PER PORTE CON ANTE IN VETRO E VETRATE
CONSIDERARE SEMPRE OPERATORI RINFORZATI*

CAR DOOR TOTAL WEIGHT PESO TOTALE PORTA DI CABINA kg LH=2000		
PL	(1)	(2)
800	121	173
850	122	175
900	135	191
950	137	195
1000	153	208
1050	154	211
1100	155	214
1150	158	219
1200	171	234
1250	173	237
1300	190	246
1350	192	249
1400	194	254
1450	180	241
1500	190	247
1550	193	252
1600	195	256
1650	197	260
1700	199	263
1750	203	269
1800	212	280

(1) WEIGHTS FOR DOORS WITH STANDARD AND DOUBLE SKIN PANELS
PESI PER PORTE CON ANTE STANDARD E TAMBURATE

(2) WEIGHTS FOR DOORS WITH GLASS AND GLASS-FRAMED PANELS
PESI PER PORTE CON ANTE IN VETRO E VETRATE

CAR DOOR PEGASUS PLUS

PORTE DI CABINA PEGASUS PLUS

Code/Codice TC.2.001999.EN
Version/Versione /

TWO PANELS CENTRAL OPENING CAR DOOR, TYPE O2/C PL=750÷1800
PORTA DI CABINA 2 ANTE OPPOSTE, TIPO O2/C PL=750÷1800

Code/Codice 3214.30.0600V01
Version/Versione B
Date/Data 12.10.2010
Page/Pagina 3.1

NOTE

WITH SEMI-AUTOMATIC TYPE SIZES DON'T CHANGE
CON IL MODELLO SEMIAUTOMATICO LE MISURE NON CAMBIANO

WITH C.D.L. DIMENSIONS DON'T CHANGE; DETAIL ON PAGE 1.18 AND 1.19
CON IL B.F.P. LE DIMENSIONI NON CAMBIANO; DETTAGLIO PAG. 1.18 E 1.19

A DETAIL ON PAGE 1.11
DETTAGLIO PAG. 1.11

FOR APPLICATION OF MIDI-SUPRA DRIVE SEE PAGE 1.2, 1.3, 1.4
APPLICAZIONE MOTORIZZAZIONE MIDI-SUPRA SECONDO PAGINE 1.2, 1.3, 1.4

FOR SCHEDULE SEE PAGE 3.1.t
TABELLA VARIABILI A PAG. 3.1.t

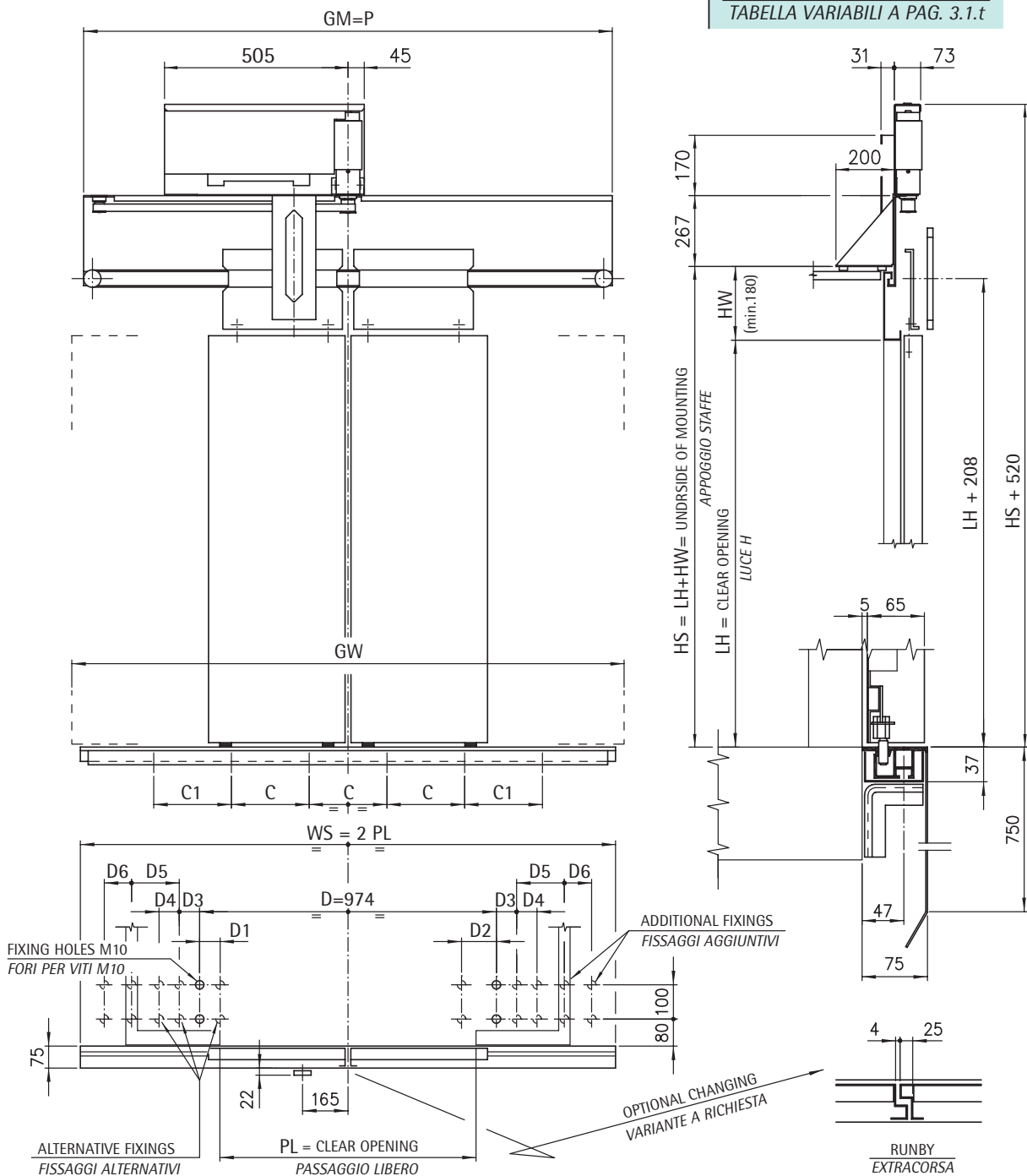



CAR DOOR PEGASUS PLUS
PORTE DI CABINA PEGASUS PLUS

Code/Codice TC.2.001999.EN
Version/Versione /

TWO PANELS CENTRAL OPENING CAR DOOR, TYPE 02/C PL=750÷1800
PORTA DI CABINA 2 ANTE OPPOSITE, TIPO 02/C PL=750÷1800

Code/Codice 3214.30.0600V01
Version/Versione A
Date/Data 12.10.2010
Page/Pagina 3.1.t

	PL	C	C1	D1	D2	D3	D4	D5	D6	GM=P
*	750	250								1590
	800									1640
*	850			62	217	/				1840
*	900	400					/			1890
	950									1940
*	1000									2140
*	1050									2190
	1100							/		2240
*	1150		/							2440
*	1200									2490
*	1250	550					163			2540
*	1300								/	2740
*	1350									2790
	1400									2840
*	1450	542								3040
*	1500	552		/	/	225				3090
	1550	562								3140
*	1600	409	409				/	500		3340
*	1650	416	416							3390
	1700	423	423							3440
*	1750	430	430							3640
*	1800	483	483							3690

* ATTENTION: GM > GW
* ATTENZIONE: GM > GW

**FOR GLASS DOORS AND GLASS-FRAMED DOORS
ALWAYS USE REINFORCED OPERATORS**

**PER PORTE CON ANTE IN VETRO E VETRATE
CONSIDERARE SEMPRE OPERATORI RINFORZATI**

CAR DOOR TOTAL WEIGHT PESO TOTALE PORTA DI CABINA kg LH=2000		
PL	(1)	(2)
750	116	173
800	126	185
850	127	188
900	134	198
950	136	202
1000	157	220
1050	159	224
1100	160	227
1150	162	231
1200	168	239
1250	170	243
1300	195	258
1350	198	263
1400	200	266
1450	180	248
1500	190	255
1550	191	258
1600	194	263
1650	196	266
1700	199	271
1750	202	276
1800	213	289

(1) WEIGHTS FOR DOORS WITH STANDARD AND DOUBLE SKIN PANELS
PESI PER PORTE CON ANTE STANDARD E TAMBURATE

(2) WEIGHTS FOR DOORS WITH GLASS AND GLASS-FRAMED PANELS
PESI PER PORTE CON ANTE IN VETRO E VETRATE

CAR DOOR PEGASUS PLUS

PORTE DI CABINA PEGASUS PLUS

Code/Codice TC.2.001999.EN
Version/Versione /

THREE PANELS TELESCOPIC CAR DOOR, TYPE 32/R-L PL=900÷2100
PORTA DI CABINA TELESCOPICA 3 ANTE, TIPO 32/R-L PL=900÷2100

Code/Codice 3214.30.0600V01
Version/Versione B
Date/Data 12.10.2010
Page/Pagina 4.1

NOTE

WITH SEMI-AUTOMATIC TYPE SIZES DON'T CHANGE
CON IL MODELLO SEMIAUTOMATICO LE MISURE NON CAMBIANO

WITH C.D.L. DIMENSIONS DON'T CHANGE; DETAIL ON PAGE 1.18 AND 1.19
CON IL B.F.P. LE DIMENSIONI NON CAMBIANO; DETTAGLIO PAG. 1.18 E 1.19

A DETAIL ON PAGE 1.11
DETTAGLIO PAG. 1.11

FOR APPLICATION OF MIDI-SUPRA DRIVE SEE PAGE 1.2.1, 1.3.1, 1.4.1
APPLICAZIONE MOTORIZZAZIONE MIDI-SUPRA SECONDO PAGINE 1.2.1, 1.3.1, 1.4.1

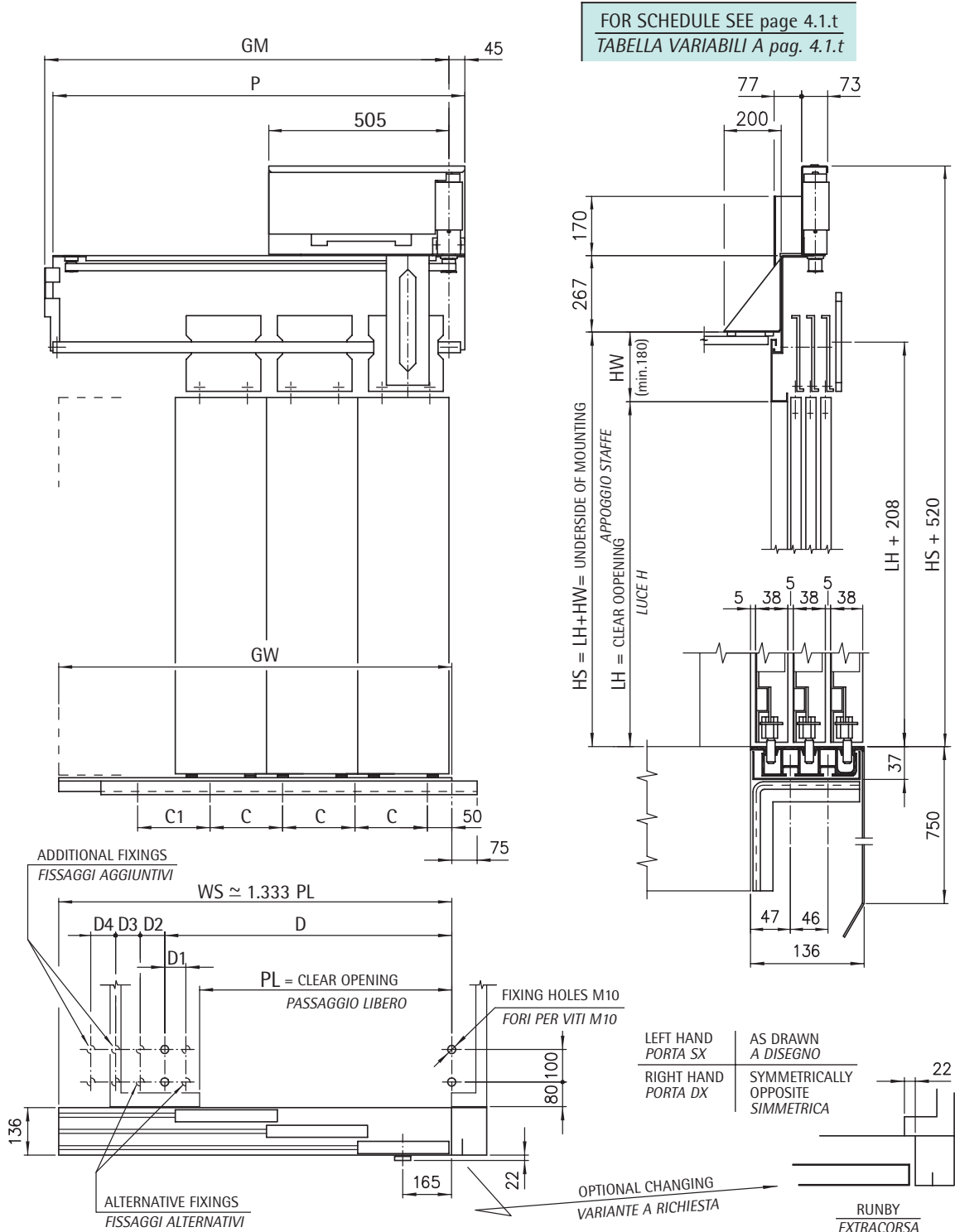



CAR DOOR PEGASUS PLUS
PORTE DI CABINA PEGASUS PLUS

Code/Codice TC.2.001999.EN
Version/Versione /

THREE PANELS TELESCOPIC CAR DOOR, TYPE 32/R-L PL=900÷2100
PORTA DI CABINA TELESCOPICA 3 ANTE, TIPO 32/R-L PL=900÷2100

Code/Codice 3214.30.0600V01
Version/Versione A
Date/Data 12.10.2010
Page/Pagina 4.1.t

	PL	C	C1	D	D1	D2	D3	D4	GW	GM	WS	P
*	900				217	/			1225	1260	1200	1300
*	950	325		912					1291	1310	1250	1350
*	1000								1358	1393	1330	1433
*	1050					225			1425	1443	1400	1483
*	1100	400		1137					1491	1493	1450	1533
*	1150		/						1558	1593	1530	1633
*	1200						/		1625	1643	1600	1683
*	1250	475		1300		287			1691	1693	1650	1733
*	1300								1758	1793	1730	1833
*	1350			1362					1825	1843	1800	1883
*	1400	550						/	1891	1893	1850	1933
*	1450	438	438						1958	1993	1930	2033
*	1500	450	450	1207					2025	2043	2000	2083
*	1550	463	463		/				2091	2093	2050	2133
*	1600	475	475						2158	2193	2130	2263
*	1650	488	488						2225	2243	2200	2283
*	1700	500	500						2291	2293	2250	2333
*	1750	513	513	1307		225			2358	2393	2330	2433
*	1800	450	450				500		2425	2443	2400	2483
*	1850	460	460						2491	2493	2450	2533
*	1900	470	470						2558	2593	2530	2633
*	1950	480	480						2625	2643	2600	2683
*	2000	490	490	1382					2691	2693	2650	2733
*	2050	500	500						2758	2793	2730	2833
*	2100	510	510					500	2825	2843	2800	2883

* ATTENTION: GM > GW
ATTENZIONE: GM > GW

FOR GLASS DOORS AND GLASS-FRAMED DOORS
ALWAYS USE REINFORCED OPERATORS

PER PORTE CON ANTE IN VETRO E VETRATE
CONSIDERARE SEMPRE OPERATORI RINFORZATI

CAR DOOR TOTAL WEIGHT
PESO TOTALE PORTA DI CABINA
kg
LH=2000

PL	(1)	(2)
900	142	206
950	144	211
1000	153	222
1050	157	228
1100	158	231
1150	166	241
1200	169	246
1250	171	250
1300	173	253
1350	183	267
1400	185	269
1450	164	252
1500	176	258
1550	177	261
1600	179	266
1650	181	270
1700	184	275
1750	186	280
1800	197	292
1850	201	298
1900	223	305
1950	225	308
2000	227	312
2050	228	315
2100	231	319

(1) WEIGHTS FOR DOORS WITH STANDARD AND DOUBLE SKIN PANELS
PESI PER PORTE CON ANTE STANDARD E TAMBURATE

(2) WEIGHTS FOR DOORS WITH GLASS AND GLASS-FRAMED PANELS
PESI PER PORTE CON ANTE IN VETRO E VETRATE

CAR DOOR PEGASUS PLUS

PORTE DI CABINA PEGASUS PLUS

Code/Codice TC.2.001999.EN
Version/Versione /

FOUR PANELS CENTRAL OPENING CAR DOOR, TYPE 42/C PL=1300÷3200
PORTA DI CABINA 4 ANTE OPPOSTE, TIPO 42/C PL=1300÷3200

Code/Codice 3214.30.0600V01
Version/Versione B
Date/Data 12.10.2010
Page/Pagina 5.1

NOTE

WITH SEMI-AUTOMATIC TYPE SIZES DON'T CHANGE
CON IL MODELLO SEMIAUTOMATICO LE MISURE NON CAMBIANO

WITH C.D.L. DIMENSIONS DON'T CHANGE; DETAIL ON PAGE 1.18 AND 1.19
CON IL B.F.P. LE DIMENSIONI NON CAMBIANO; DETTAGLIO PAG. 1.18 E 1.19

A DETAIL ON PAGE 1.11
DETTAGLIO PAG. 1.11

FOR APPLICATION OF MIDI-SUPRA DRIVE SEE PAGE 1.2.1, 1.3.1, 1.4.1
APPLICAZIONE MOTORIZZAZIONE MIDI-SUPRA SECONDO PAGINE 1.2.1, 1.3.1, 1.4.1

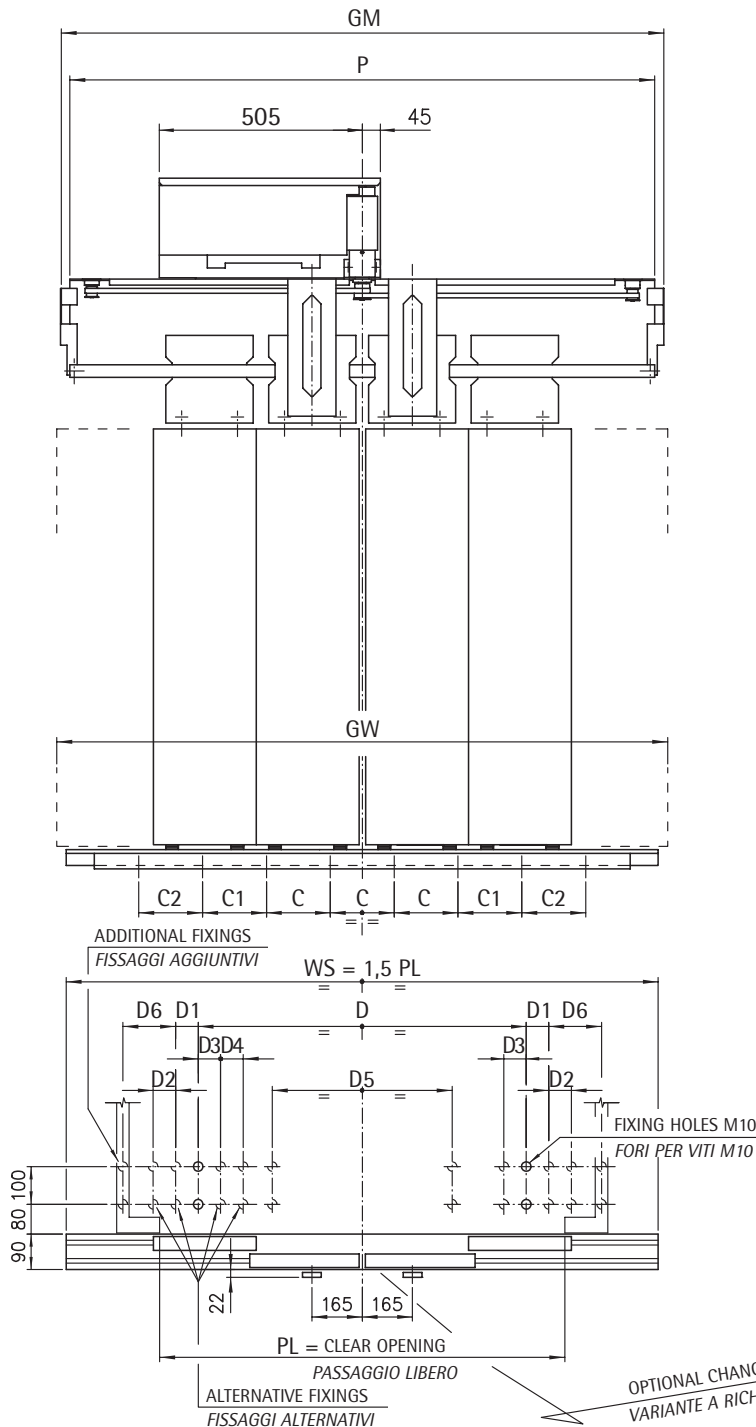

FOR SCHEDULE SEE PAGE 5.1.t
TABELLA VARIABILI A PAG. 5.1.t

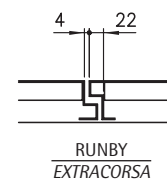
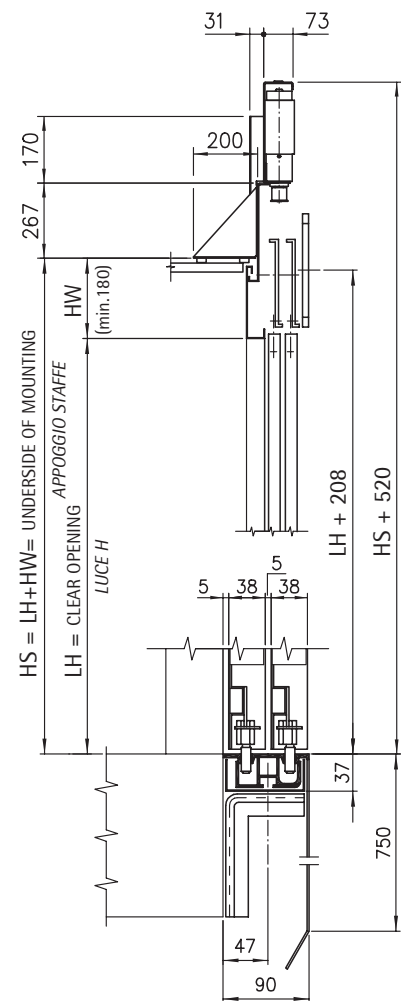



CAR DOOR PEGASUS PLUS
PORTE DI CABINA PEGASUS PLUS

Code/Codice TC.2.001999.EN
Version/Versione /

FOUR PANELS CENTRAL OPENING CAR DOOR, TYPE 42/C PL=1300÷3200
PORTA DI CABINA 4 ANTE OPPOSTE, TIPO 42/C PL=1300÷3200

Code/Codice 3214.30.0600V01
Version/Versione A
Date/Data 12.10.2010
Page/Pagina 5.1.t

	PL	C	C1	C2	D	D1	D2	D3	D4	D5	D6	M1	GM	P	GW	WS
*	1300												2055	2040	2000	1950
*	1350				1424	/	/	225	62			820	2105	2090	2075	2025
*	1400												2205	2190	2150	2100
*	1450												2255	2240	2225	2175
*	1500	550	/										2305	2290	2300	2250
*	1550												2355	2340	2375	2325
*	1600				974		163			/			2405	2390	2450	2400
*	1650											610	2455	2440	2525	2475
*	1700												2655	2640	2600	2550
*	1750												2705	2690	2675	2625
*	1800												2755	2740	2750	2700
*	1850												2805	2790	2825	2775
*	1900							/					2855	2840	2900	2850
*	1950												2905	2890	2975	2925
*	2000												3105	3090	3050	3000
*	2050	500	500	/	1850						/		3155	3140	3125	3075
*	2100												3205	3190	3200	3150
*	2150												3255	3240	3275	3225
*	2200												3305	3290	3350	3300
*	2250												3355	3340	3425	3375
*	2300												3555	3540	3500	3450
*	2350												3605	3590	3575	3525
*	2400												3655	3640	3650	3600
*	2450												3705	3690	3725	3675
*	2500												3755	3740	3800	3750
*	2550	486	486			225	/		/	500		800	3805	3790	3875	3825
*	2600												4005	3990	3950	3900
*	2650												4055	4040	4025	3975
*	2700												4105	4090	4100	4050
*	2750												4155	4140	4175	4125
*	2800				2350			238					4205	4190	4250	4200
*	2850	428	428	428									4255	4240	4325	4275
*	2900	463	463	463									4455	4440	4400	4350
*	2950	469	469	469									4505	4490	4475	4425
*	3000	474	474	474									4555	4540	4550	4500
*	3050	480	480	480									4605	4590	4625	4575
*	3100	486	486	486							500		4655	4640	4700	4650
*	3150	491	491	491									4705	4690	4775	4725
*	3200	497	497	497									4905	4890	4850	4800

* ATTENTION: GM > GW
* ATTENZIONE: GM > GW

FOR GLASS DOORS AND GLASS-FRAMED DOORS
ALWAYS USE REINFORCED OPERATORS

PER PORTE CON ANTE IN VETRO E VETRATE
CONSIDERARE SEMPRE OPERATORI RINFORZATI

CAR DOOR TOTAL WEIGHT PESO TOTALE PORTA DI CABINA kg LH=2000		
PL	(1)	(2)
1300	185	275
1350	188	280
1400	189	284
1450	190	287
1500	204	303
1550	206	307
1600	207	310
1650	208	313
1700	211	318
1750	212	321
1800	247	358
1850	250	363
1900	273	389
1950	274	392
2000	289	399
2050	292	404
2100	294	408
2150	294	410
2200	297	415
2250	299	419
2300	299	422
2350	301	426
2400	333	460
2450	334	463
2500	336	467
2550	371	481
2600	372	483
2650	374	487
2700	376	490
2750	379	495
2800	280	398
2850	325	445
2900	329	451
2950	331	455
3000	346	461
3050	348	464
3100	351	469
3150	354	474
3200	356	478

- (1) WEIGHTS FOR DOORS WITH STANDARD AND DOUBLE SKIN PANELS
PESI PER PORTE CON ANTE STANDARD E TAMBURATE
- (2) WEIGHTS FOR DOORS WITH GLASS AND GLASS-FRAMED PANELS
PESI PER PORTE CON ANTE IN VETRO E VETRATE

CAR DOOR PEGASUS PLUS
PORTE DI CABINA PEGASUS PLUS

Code/Codice TC.2.001999.EN
Version/Versione /

SIX PANELS CENTRAL OPENING CAR DOOR, TYPE 62/C PL=1800÷3200
PORTE DI CABINA 6 ANTE OPPOSTE, TIPO 62/C PL=1800÷3200

Code/Codice 3214.30.0600V01
Version/Versione B
Date/Data 12.10.2010
Page/Pagina 6.1

NOTE

WITH SEMI-AUTOMATIC TYPE SIZES DON'T CHANGE
CON IL MODELLO SEMIAUTOMATICO LE MISURE NON CAMBIANO

WITH C.D.L. DIMENSIONS DON'T CHANGE; DETAIL ON PAGE 1.18 AND 1.19
CON IL B.F.P. LE DIMENSIONI NON CAMBIANO; DETTAGLIO PAG. 1.18 E 1.19

A DETAIL ON PAGE 1.11
DETTAGLIO PAG. 1.11

FOR APPLICATION OF MIDI-SUPRA DRIVE SEE PAGE 1.2.2, 1.3.2, 1.4.2
APPLICAZIONE MOTORIZZAZIONE MIDI-SUPRA SECONDO PAGINE 1.2.2, 1.3.2, 1.4.2

FOR SCHEDULE SEE PAGE 6.1.t
TABELLA VARIABILI A PAG. 6.1.t

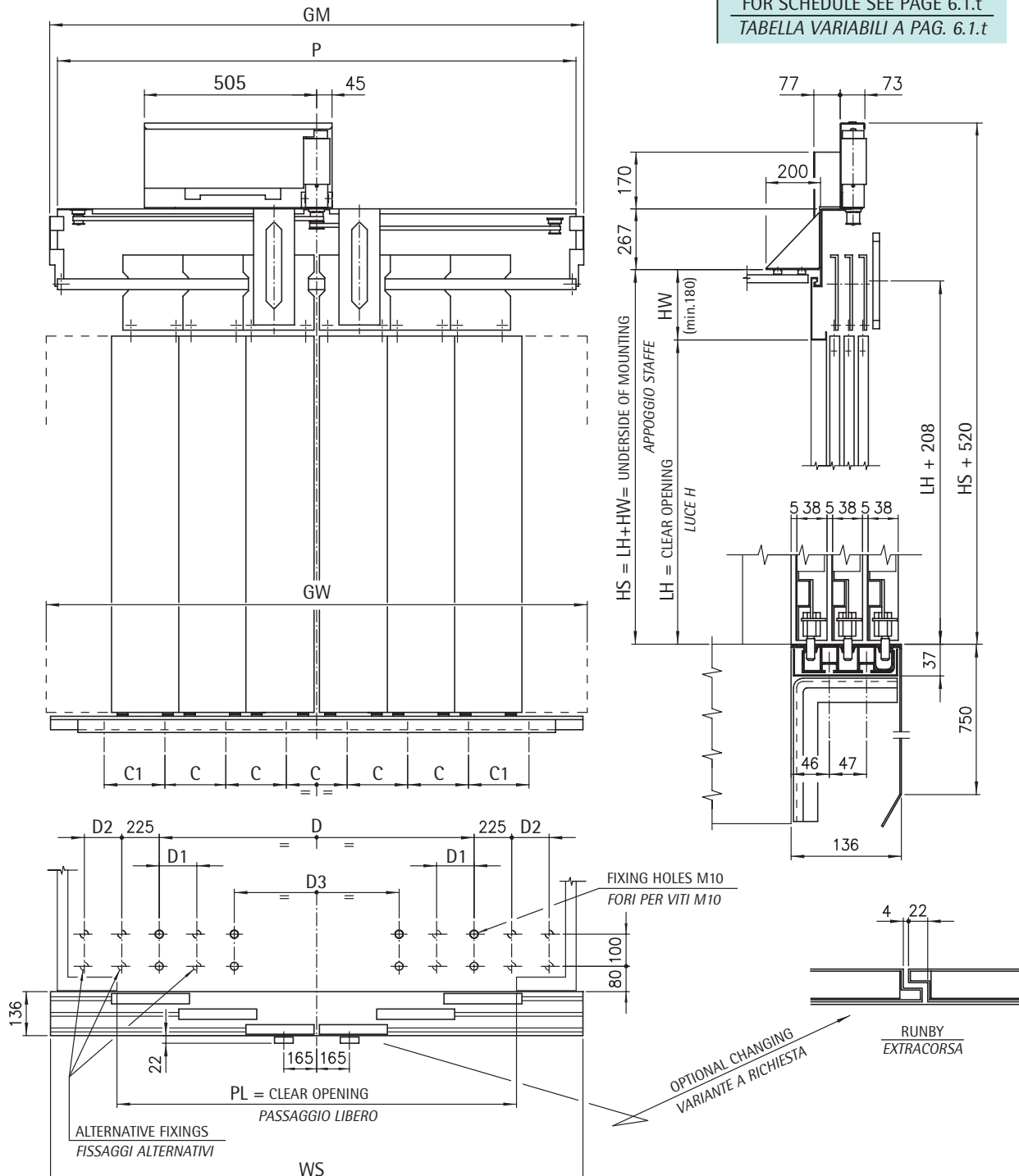



CAR DOOR PEGASUS PLUS
PORTE DI CABINA PEGASUS PLUS

Code/Codice TC.2.001999.EN
Version/Versione /

SIX PANELS CENTRAL OPENING CAR DOOR, TYPE 62/C PL=1800÷3200
PORTE DI CABINA 6 ANTE OPPOSTE, TIPO 62/C PL=1800÷3200

Code/Codice 3214.30.0600V01
Version/Versione A
Date/Data 12.10.2010
Page/Pagina 6.1.t

	PL	C	C1	D	D1	D2	D3	M1	GM	P	GW	WS
*	1800	440					/	610	2505	2490	2450	2400
*	1850	450							2555	2540	2516	2450
*	1900	460							2605	2590	2583	2530
*	1950	470							2655	2640	2650	2600
*	2000	480							2771	2756	2716	2650
*	2050	490		1850	/				2821	2806	2783	2730
*	2100	500							2871	2856	2850	2800
*	2150	510							2921	2906	2916	2850
*	2200	520							2971	2956	2983	2930
*	2250	530							3021	3006	3050	3000
*	2300	410	/						3171	3156	3116	3050
*	2350	417				/			3221	3206	3183	3130
*	2400	424							3271	3256	3250	3200
*	2450	431							3321	3306	3316	3250
*	2500	439							3371	3356	3383	3330
*	2550	446					500	800	3421	3406	3450	3400
*	2600	453							3571	3556	3516	3450
*	2650	460							3621	3606	3583	3530
*	2700	489							3671	3656	3650	3600
*	2750	493							3721	3706	3716	3650
*	2800	500		2350	238				3771	3756	3783	3730
*	2850	394	394						3821	3806	3850	3800
*	2900	400	400						3971	3956	3916	3850
*	2950	406	406						4021	4006	3983	3930
*	3000	411	411						4071	4056	4050	4000
*	3050	417	417						4121	4106	4116	4050
*	3100	422	422			500			4171	4156	4183	4130
*	3150	428	428						4221	4206	4250	4200
*	3200	433	433						4371	4356	4316	4250

* ATTENTION: GM > GW
* ATTENZIONE: GM > GW

CAR DOOR TOTAL WEIGHT PESO TOTALE PORTA DI CABINA		
kg LH=2000		
PL	(1)	(2)
1800	203	332
1850	206	337
1900	213	346
1950	215	350
2000	217	354
2050	220	359
2100	221	363
2150	223	367
2200	226	372
2250	228	376
2300	239	389
2350	241	394
2400	244	399
2450	245	402
2500	247	406
2550	249	410
2600	252	415
2650	255	420
2700	264	431
2750	268	437
2800	293	464
2850	295	469
2900	298	474
2950	317	495
3000	318	483
3050	320	487
3100	324	493
3150	325	496
3200	326	497

FOR GLASS DOORS AND GLASS-FRAMED DOORS
ALWAYS USE REINFORCED OPERATORS

PER PORTE CON ANTE IN VETRO E VETRATE
CONSIDERARE SEMPRE OPERATORI RINFORZATI

- (1) WEIGHTS FOR DOORS WITH STANDARD AND DOUBLE SKIN PANELS
PESI PER PORTE CON ANTE STANDARD E TAMBURATE
- (2) WEIGHTS FOR DOORS WITH GLASS AND GLASS-FRAMED PANELS
PESI PER PORTE CON ANTE IN VETRO E VETRATE

CAR DOOR PEGASUS PLUS

PORTE DI CABINA PEGASUS PLUS

Code/Codice TC.2.001999.EN
Version/Versione /

ONE PANEL CAR DOOR, TYPE 72/R-L PL=600÷1400
PORTA DI CABINA 1 ANTA, TIPO 72/R-L PL=600÷1400

Code/Codice 3214.30.0600V01
Version/Versione B
Date/Data 12.10.2010
Page/Pagina 7.1

NOTE

WITH SEMI-AUTOMATIC TYPE SIZES DON'T CHANGE
CON IL MODELLO SEMIAUTOMATICO LE MISURE NON CAMBIANO

WITH C.D.L. DIMENSIONS DON'T CHANGE; DETAIL ON PAGE 1.18 AND 1.19
CON IL B.F.P. LE DIMENSIONI NON CAMBIANO; DETTAGLIO PAG. 1.18 E 1.19

A DETAIL ON PAGE 1.11
DETTAGLIO PAG. 1.11

FOR APPLICATION OF MIDI-SUPRA DRIVE SEE PAGE 1.2.2, 1.3.2, 1.4.2
APPLICAZIONE MOTORIZZAZIONE MIDI-SUPRA SECONDO PAGINE 1.2.2, 1.3.2, 1.4.2

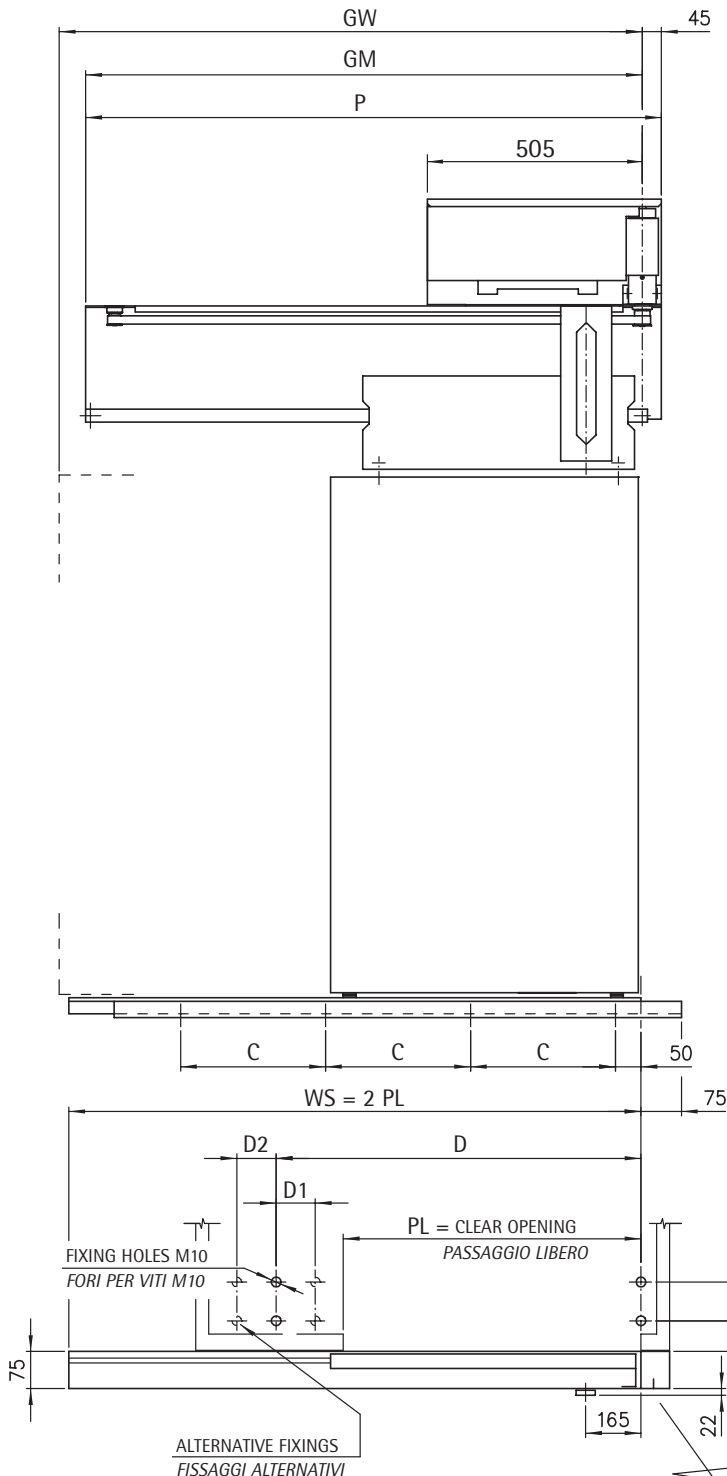

FOR SCHEDULE SEE PAGE 7.1.t
TABELLA VARIABILI A PAG. 7.1.t

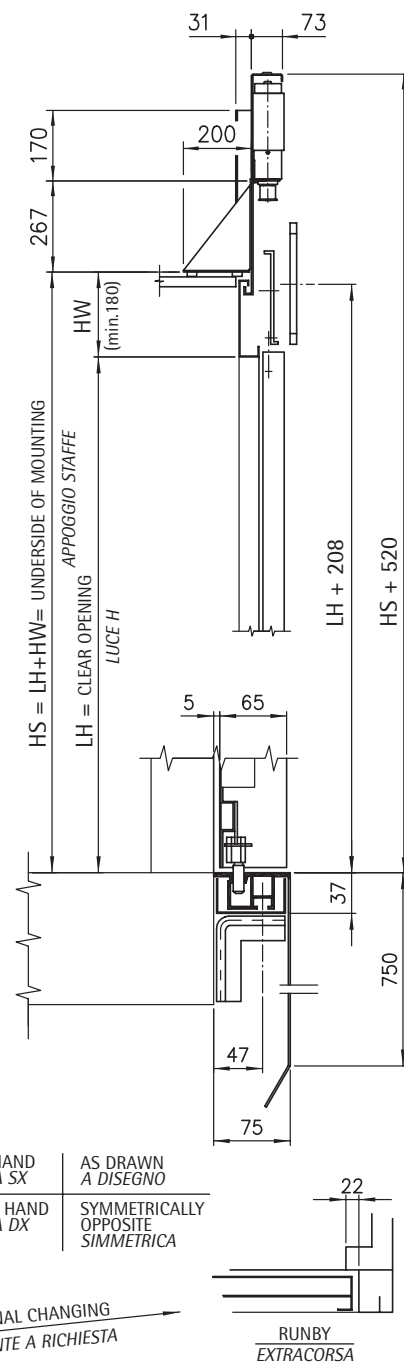

LEFT HAND PORTA SX AS DRAWN A DISEGNO
RIGHT HAND PORTA DX SYMMETRICALLY OPPOSITE SIMMETRICA

OPTIONAL CHANGING VARIANTE A RICHIESTA



CAR DOOR PEGASUS PLUS
PORTE DI CABINA PEGASUS PLUS

Code/Codice TC.2.001999.EN
Version/Versione /

ONE PANEL CAR DOOR, TYPE 72/R-L PL=600÷1400
PORTA DI CABINA 1 ANTA, TIPO 72/R-L PL=600÷1400

Code/Codice 3214.30.0600V01
Version/Versione A
Date/Data 12.10.2010
Page/Pagina 7.1.t

	PL	C	D	D1	D2	GM	P
*	600	250	912			1283	1328
*	650			217	/	1391	1436
*	700	378				1458	1503
*	750		1137			1583	1628
*	800	400			225	1691	1736
*	850					1758	1803
*	900	475				1883	1928
*	950					2008	2053
*	1000	550				2108	2153
*	1050	483				2158	2203
*	1100	495		/		2308	2353
*	1150	508	1300		287	2358	2403
*	1200	446				2508	2553
*	1250	456				2558	2603
*	1300	466				2708	2753
*	1350	476				2758	2803
*	1400	486				2908	2953

* ATTENTION: GM > GW
* ATTENZIONE: GM > GW

FOR GLASS DOORS AND GLASS-FRAMED DOORS
ALWAYS USE REINFORCED OPERATORS

PER PORTE CON ANTE IN VETRO E VETRATE
CONSIDERARE SEMPRE OPERATORI RINFORZATI

CAR DOOR TOTAL WEIGHT PESO TOTALE PORTA DI CABINA kg LH=2000		
PL	(1)	(2)
600	107	142
650	117	149
700	126	160
750	102	135
800	105	139
850	108	144
900	114	152
950	124	161
1000	130	169
1050	148	188
1100	150	193
1150	156	198
1200	162	205
1250	165	210
1300	167	214
1350	170	219
1400	173	223

(1) WEIGHTS FOR DOORS WITH STANDARD AND DOUBLE SKIN PANELS
PESI PER PORTE CON ANTE STANDARD E TAMBURATE

(2) WEIGHTS FOR DOORS WITH GLASS AND GLASS-FRAMED PANELS
PESI PER PORTE CON ANTE IN VETRO E VETRATE